

C5402	ODVIJAČ PH-1 100MM CR-MO	135,00
C5403	ODVIJAČ PH-2 38MM CR-MO	112,00
C5405	ODVIJAČ PH-2 150MM CR-MO	171,00
C5406	ODVIJAČ PH-3 150MM CR-MO	235,00
C5412	ODVIJAČ PZ-1 100MM CR-MO	131,00
C5414	ODVIJAČ PZ-2 100MM CR-MO	167,00
C5421	ODVIJAČ RAVNI 3x100 MM CR-MO	105,00
C5422	ODVIJAČ RAVNI 4x100 MM CR-MO	117,00
C5423	ODVIJAČ RAVNI 5x100 MM CR-MO	131,00
C5424	ODVIJAČ RAVNI 6x38 MM CR-MO	111,00
C5425	ODVIJAČ RAVNI 6x100 MM CR-MO	165,00
C5426	ODVIJAČ RAVNI 8x150 MM CR-MO	235,00
C5451	ODVIJAČ PH-1 300MM CR-MO	235,00
C5452	ODVIJAČ PH-2 300MM CR-MO	235,00
C5457	ODVIJAČ RAVNI 6x300MM CR-MO	235,00



Wkrętaki MINI 6 elementów  
Screwdrivers MINI set 6 pcs



Wkrętaki TORX MINI 6 elementów  
Screwdrivers TORX MINI set 6 pcs



Wkrętak dwustronny  
Single two way screwdriver



C5366	MINI GARN. ODVIJAČA 6 PCS RAVNI+ PH CR-MO	698,00
C5367	MINI GARN.TORX ODVIJAČA 6 PCS CR-MO	645,00
C5365	KOMBINOVANI ODVIJAČ PH2-RAVNI, 6MM	356,00

Wkrętaki, 6 elementów  
Screwdrivers set 6 pcs



Wkrętaki, 9 elementów  
Screwdrivers set 9 pcs



C5370	ODVIJAČI SET 6 PCS	917,00
C5372	ODVIJAČI SET 9 PCS	1912,00

Wkrętaki słusarskie 4 elementy  
Go-through screwdrivers 4 pcs



Wkrętaki + bity, 18 elementów  
Screwdrivers and bits set, 18 pcs



C5399	ODVIJAČI UDARNI SET 4 PCS	1060,00
C5373	ODVIJAČI I BITOVI SET 58 PCS	2933,00

Kombinerki  
Combination pliers



Obcinaczkę boczne  
Diagonal cutting pliers



Obcinaczkę do kabli  
Cable cutters



C7041	KOMBINOVANA KLJEŠTA 180MM	458,00
C7042	KOMBINOVANA KLJEŠTA 200MM	490,00
C7066	SEČICE 180MM	565,00
C7070	SEČICE 200MM WITH HANGER	602,00
C7071	SEČICE ZA KAVLOVE 200MM	903,00

Szczypce do izolacji  
Isolation pliers







Szczypce wydłużone wygięte  
Bent long nose pliers





Szczypce wydłużone proste  
Straight long nose pliers



																											
<table border="1"><tr><th>Index</th><th>L [mm]</th><th>Ø</th></tr><tr><td>C7067</td><td>160</td><td>6/36</td></tr></table>	Index	L [mm]	Ø	C7067	160	6/36	<table border="1"><tr><th>Index</th><th>L [mm]</th><th>Ø</th></tr><tr><td>C7068</td><td>160</td><td>6/36</td></tr><tr><td>C7069</td><td>200</td><td>6/36</td></tr></table>	Index	L [mm]	Ø	C7068	160	6/36	C7069	200	6/36	<table border="1"><tr><th>Index</th><th>L [mm]</th><th>Ø</th></tr><tr><td>C7063</td><td>160</td><td>6/36</td></tr><tr><td>C7064</td><td>200</td><td>6/36</td></tr></table>	Index	L [mm]	Ø	C7063	160	6/36	C7064	200	6/36	
Index	L [mm]	Ø																									
C7067	160	6/36																									
Index	L [mm]	Ø																									
C7068	160	6/36																									
C7069	200	6/36																									
Index	L [mm]	Ø																									
C7063	160	6/36																									
C7064	200	6/36																									
C7067	KLJEŠTA ZA IZOLACIJU 160MM		563,00																								
C7068	ŠPIC KLJEŠTA KRIVA 160MM		488,00																								
C7063	ŠPIC KLJEŠTA PRAVA 160MM		472,00																								
Szczypcy tynkarskie Tower pliers		Szczypcy do rur Water pump pliers																									
																											
<table border="1"><tr><th>Index</th><th>L [mm]</th><th>Ø</th></tr><tr><td>C7056</td><td>275</td><td>4/38</td></tr></table>	Index	L [mm]	Ø	C7056	275	4/38	<table border="1"><tr><th>Index</th><th>L [mm]</th><th>Ø</th></tr><tr><td>C7072</td><td>250</td><td>6/38</td></tr></table>	Index	L [mm]	Ø	C7072	250	6/38														
Index	L [mm]	Ø																									
C7056	275	4/38																									
Index	L [mm]	Ø																									
C7072	250	6/38																									
C7056	ARMIRACKA KLJEŠTA 275MM		898,00																								
C7072	PAPAGAJ KLJEŠTA 250 MM		921,00																								

Szczypcy do ściągania izolacji, uniwersalne Automatic wire stripper, universal		Klucz „SZWED” Adjustable wrench		Klucz „FRANCUZ” Monkey wrench																																						
	<table border="1"><tr><th>Index</th><th>Rozebrań sztyrak [mm]</th><th>L [mm]</th><th>Ø</th></tr><tr><td>C6506</td><td>0-19</td><td>4/150</td><td>6/60</td></tr><tr><td>C6508</td><td>0-24</td><td>8/200</td><td>6/60</td></tr><tr><td>C6510</td><td>0-28</td><td>10/250</td><td>6/36</td></tr><tr><td>C6512</td><td>0-32</td><td>12/300</td><td>6/24</td></tr></table>	Index	Rozebrań sztyrak [mm]	L [mm]	Ø	C6506	0-19	4/150	6/60	C6508	0-24	8/200	6/60	C6510	0-28	10/250	6/36	C6512	0-32	12/300	6/24		<table border="1"><tr><th>Index</th><th>Rozebrań sztyrak [mm]</th><th>Ø</th></tr><tr><td>C7675</td><td>0-25</td><td>1/10</td></tr><tr><td>C7676</td><td>0-35</td><td>1/10</td></tr><tr><td>C7677</td><td>0-45</td><td>1/10</td></tr><tr><td>C7678</td><td>0-55</td><td>1/10</td></tr><tr><td>C7679</td><td>0-65</td><td>1/10</td></tr></table>	Index	Rozebrań sztyrak [mm]	Ø	C7675	0-25	1/10	C7676	0-35	1/10	C7677	0-45	1/10	C7678	0-55	1/10	C7679	0-65	1/10	
Index	Rozebrań sztyrak [mm]	L [mm]	Ø																																							
C6506	0-19	4/150	6/60																																							
C6508	0-24	8/200	6/60																																							
C6510	0-28	10/250	6/36																																							
C6512	0-32	12/300	6/24																																							
Index	Rozebrań sztyrak [mm]	Ø																																								
C7675	0-25	1/10																																								
C7676	0-35	1/10																																								
C7677	0-45	1/10																																								
C7678	0-55	1/10																																								
C7679	0-65	1/10																																								
<table border="1"><tr><th>Index</th><th>Ø</th></tr><tr><td>C7180</td><td>10/40</td></tr></table>	Index	Ø	C7180	10/40																																						
Index	Ø																																									
C7180	10/40																																									

C7180	AUTOMATIC KLJEŠTA ZA ELEKTRICARE		1213,00
C6508	UNIVERZALNI KLJUČ 8' 0-24MM		560,00
C6512	UNIVERZALNI KLJUČ 12' 0-38MM		1253,00
C7679	FRANCUSKI KLJUČ 0-65MM		4990,00

Szczypcy do rur typ S Pipe wrench	Nożyce do blachy typ PELIKAN Tinman's snips PELIKAN type	Obcinak do rur PCV PCV pipe cutters																																
																																		
<table border="1"><tr><th>Index</th><th>Rozebrań sztyrak [mm]</th><th>L [mm]</th><th>Ø</th></tr><tr><td>C7579</td><td>0-5</td><td>230</td><td>1/48</td></tr><tr><td>C7580</td><td>1</td><td>320</td><td>1/36</td></tr><tr><td>C7581</td><td>1,5</td><td>420</td><td>1/24</td></tr><tr><td>C7582</td><td>2</td><td>500</td><td>1/12</td></tr><tr><td>C7583</td><td>3</td><td>650</td><td>1/6</td></tr></table>	Index	Rozebrań sztyrak [mm]	L [mm]	Ø	C7579	0-5	230	1/48	C7580	1	320	1/36	C7581	1,5	420	1/24	C7582	2	500	1/12	C7583	3	650	1/6	<table border="1"><tr><th>Index</th><th>Ø</th></tr><tr><td>C0307</td><td>6/24</td></tr></table>	Index	Ø	C0307	6/24	<table border="1"><tr><th>Index</th><th>Ø</th></tr><tr><td>C0295</td><td>10/50</td></tr></table>	Index	Ø	C0295	10/50
Index	Rozebrań sztyrak [mm]	L [mm]	Ø																															
C7579	0-5	230	1/48																															
C7580	1	320	1/36																															
C7581	1,5	420	1/24																															
C7582	2	500	1/12																															
C7583	3	650	1/6																															
Index	Ø																																	
C0307	6/24																																	
Index	Ø																																	
C0295	10/50																																	
C7579	ROCANGLE, 0,5', 230MM		854,00																															
C7580	ROCANGLE 1', 320MM		1095,00																															
C7581	ROCANGLE 1,5', 420MM		1724,00																															
C7582	ROCANGLE 2', 550MM		2775,00																															
C7583	ROCANGLE 3' EXCLUSIVE		4293,00																															
C0307	MAKAZE ZA LIM PELIKAN TYPE 300 MM		1195,00																															
C0295	MAKAZE ZA PVC CEVI 42mm		1062,00																															

Szczypcy zaciskowe Morse'a Self-tensing plier														
<table border="1"><tr><th>Index</th><th>L [mm]</th><th>Ø</th></tr><tr><td>C7140</td><td>250</td><td>6/38</td></tr></table>	Index	L [mm]	Ø	C7140	250	6/38	<table border="1"><tr><th>Index</th><th>L [mm]</th><th>Ø</th></tr><tr><td>C7141</td><td>230</td><td>6/38</td></tr></table>	Index	L [mm]	Ø	C7141	230	6/38	
Index	L [mm]	Ø												
C7140	250	6/38												
Index	L [mm]	Ø												
C7141	230	6/38												
C7140	GRIP KLJEŠTA 250mm B7140		589,00											
C7141	GRIP KLJEŠTA DUGOG NOSA 230 MM		617,00											



C7146	GRIP KLJEŠTA C-TYPE 280 MM	998,00
C7144	GRIP KLJEŠTA LIMARSKA 250 MM	1112,00
C7143	GRIP KLJEŠTA VARILAČKA 250 MM	1043,00

Nožice do drutu MINI  
Wire cutters MINI



Nožice do pretvov  
Bolt cutters



C0323	MAKAZE ZE ŽICU 210 MM	470,00
C0331	MAKAZE ZE ŽICU 18'/450 MM	2365,00
C0332	MAKAZE ZE ŽICU 24'/600 MM	3655,00
C0334	MAKAZE ZE ŽICU 36'/900 MM	6418,00



Model	Ukupna dužina	Ukupna dužina
C0331	18' / 450	1/10
C0332	24' / 600	1/10
C0334	36' / 900	1/8



C7011	180MM ZEGER PRAVA OTVARAJUCA	413,00
C7012	180MM ZEGER PRAVA ZATVARAJUCA	413,00
C7013	180MM ZEGER KRIVA OTVARAJUCA	413,00
C7014	180MM ZEGER KRIVA ZATVARAJUCA	413,00
X0125	125MM MINI KOMBINOVANA KLJESTA	395,00
X0126	125MM MINI SPIC KLJESTA	395,00
X0127	125MM MINI SECICE	395,00
X0128	125MM MINI KRAJ SECICE	395,00



C3910	GER SA TESTEROM TEFLON 300	1402,00
C1919	RUČNA TESTERA TEFLON, 500MM	899,00
C1909	RUČNA TESTERA ZA BETON TEFLON, 700MM, 32 CARBIDNA ZUBA	2603,00
C1901	RUČNA TESTERA ZA GIPS TEFLON, 150MM	538,00
C1913	PREKLOPNA RUČNA TESTERA TEFLON, 180MM	851,00

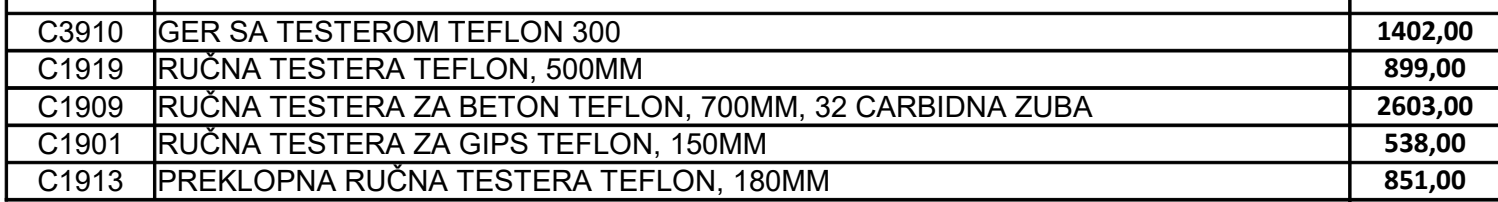

C3392	LIST BONSEKA METAL/DRVO BOX 72 PCS	ili 38.00/komad	2736,00
C1900	RAM BONSEK PROFI 300MM PL (PL001)		892,00
C1903	RAM BONSEK 300MM		287,00
B3200	NOŽ ZA STAKLO JOBO		365,00

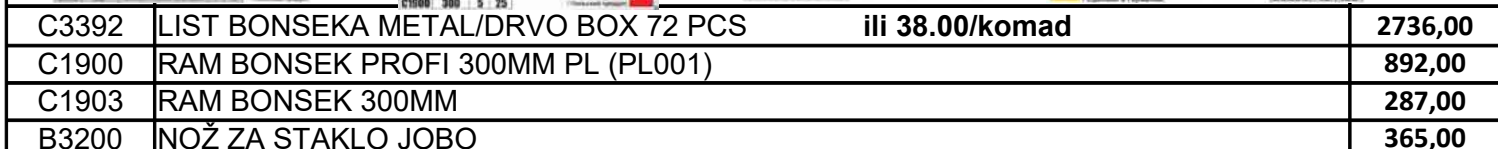

C9110	SKALPER 18MM, TUBE 12/1	ili 39.00/komad	468,00
C9101	SKALPER 18MM SA 3 NOŽA		205,00
C9114	SKALPER 25 MM		250,00
C9108	ALUMINIUM SKALPER 18MM		245,00
C9107	PREKLOPNI SKALPER TRAPEZNI NOŽ 5 BLADES		342,00

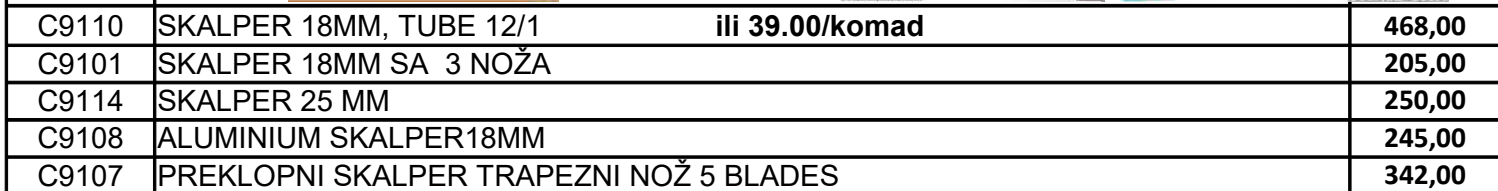

C9111	NOŽ ZA SKALPER 10PCS/BOX		60,00
-------	--------------------------	--	-------





C9115	NOŽ ZA SKALPER 18MM, SK2 STEEL, 10PCS/BOX EXCLUSIVE	145,00
C9118	NOŽ ZA SKALPER 25 MM EXCLUSIVE SK5 STEEL 10PCS/BOX	225,00
C9116	NOŽ ZA SKALPER TRAPEZNI SK-5 STEEL, 10 PCS/BOX EXCLUSIVE	171,00
C9117	NOŽ ZA SKALPER TRAPEZNI ZA IZOLACIJU SK-5 STEEL, 10PCS/BOX, EXCLUSIVE	272,00
C9120	NOŽ - 2 BLADES 180MM	615,00
C9121	KALEMARSKI NOŽ 185MM	615,00
C9124	NOŽ 205MM	745,00
C9130	LOVACKI NOŽ U FUTROLI COMPAS 300MM	1105,00
C9131	LOVACKI NOŽ U FUTROLI 340MM	1167,00
C9137	MAČETA U FUTROLI 60CM EXCLUSIVE	760,00
<b>OKASTO VILJUŠKASTI KLJUČEV</b>		
C6308	OKASTO-VILJUŠKASTI KLJUČ 8 MM	111,00
C6309	OKASTO-VILJUŠKASTI KLJUČ 9 MM	113,00
C6310	OKASTO-VILJUŠKASTI KLJUČ 10 MM	118,00
C6311	OKASTO-VILJUŠKASTI KLJUČ 11 MM	131,00
C6312	OKASTO-VILJUŠKASTI KLJUČ 12 MM	143,00
C6313	OKASTO-VILJUŠKASTI KLJUČ 13 MM	151,00
C6314	OKASTO-VILJUŠKASTI KLJUČ 14 MM	166,00
C6315	OKASTO-VILJUŠKASTI KLJUČ 15 MM	189,00
C6316	OKASTO-VILJUŠKASTI KLJUČ 16 MM	203,00
C6317	OKASTO-VILJUŠKASTI KLJUČ 17 MM	218,00
C6318	OKASTO-VILJUŠKASTI KLJUČ 18 MM	248,00
C6319	OKASTO-VILJUŠKASTI KLJUČ 19 MM	280,00
C6320	OKASTO-VILJUŠKASTI KLJUČ 20 MM	349,00
C6321	OKASTO-VILJUŠKASTI KLJUČ 21 MM	365,00
C6322	OKASTO-VILJUŠKASTI KLJUČ 22 MM	375,00
C6323	OKASTO-VILJUŠKASTI KLJUČ 23 MM	421,00
C6324	OKASTO-VILJUŠKASTI KLJUČ 24 MM	500,00
C6325	OKASTO-VILJUŠKASTI KLJUČ 25 MM	527,00
C6326	OKASTO-VILJUŠKASTI KLJUČ 26 MM	599,00
C6327	OKASTO-VILJUŠKASTI KLJUČ 27 MM	683,00
C6328	OKASTO-VILJUŠKASTI KLJUČ 28 MM	750,00
C6329	OKASTO-VILJUŠKASTI KLJUČ 29 MM	929,00
C6330	OKASTO-VILJUŠKASTI KLJUČ 30 MM	992,00
C6332	OKASTO-VILJUŠKASTI KLJUČ 32 MM	1060,00
C7342	GARN.OKASTO-VILJUŠKASTIH KLJUČEVA 6-22MM, 8PCS	1375,00
C7344	GARN.OKASTO-VILJUŠKASTIH KLJUČEVA 6-32MM 12 PCS	4081,00
C7345	GARN.OKASTO-VILJUŠKASTIH KLJUČEVA 6-32MM, 24PCS	6893,00
<b>VILJUŠKASTI KLJUČEVI I GARNITU</b>		
C6037	VILJUŠKASTI KLJUČ 10x13 MM	195,00
C6038	VILJUŠKASTI KLJUČ 13x17 MM	270,00
C6039	VILJUŠKASTI KLJUČ 17x19 MM	369,00
C6042	VILJUŠKASTI KLJUČ 10x11 MM	146,00
C6043	VILJUŠKASTI KLJUČ 12x13 MM	161,00
C6044	VILJUŠKASTI KLJUČ 14x15 MM	213,00
C6045	VILJUŠKASTI KLJUČ 16x17 MM	257,00
C6046	VILJUŠKASTI KLJUČ 18x19 MM	322,00
C6047	VILJUŠKASTI KLJUČ 20x22 MM	389,00
C6048	VILJUŠKASTI KLJUČ 21x23 MM	458,00
C6049	VILJUŠKASTI KLJUČ 24x27 MM	584,00
C6050	VILJUŠKASTI KLJUČ 25x28 MM	644,00

C6051	VILJUŠKASTI KLJUČ 30x32 MM		758,00
C6031	GARN.VILJUŠKASTIH KLJUČEVA 6-22MM, 8PCS		1833,00
C6033	GARN.VILJUŠKASTIH KLJUČEVA 6-32MM, 12PCS		4626,00
<b>OKASTI KLJUČEVI I GARN</b>			
C6841	OKASTI KLJUČ 8x9MM		210,00
C6842	OKASTI KLJUČ 10x11MM		227,00
C6843	OKASTI KLJUČ 12x13MM		247,00
C6844	OKASTI KLJUČ 14x15MM		319,00
C6845	OKASTI KLJUČ 16x17MM		356,00
C6846	OKASTI KLJUČ 18x19MM		411,00
C6847	OKASTI KLJUČ 20x22MM		567,00
C6848	OKASTI KLJUČ 21x23MM WITH HANGER		599,00
C6849	OKASTI KLJUČ 24x27MM WITH HANGER		830,00
C6850	OKASTI KLJUČ 25x28MM WITH HANGER		830,00
C6851	OKASTI KLJUČ 30x32MM WITH HANGER		1030,00
C6831	GARN.OKASTIH KLJUČEVA 6-22MM, 8PCS, FULLY POLISHED		2495,00
C6833	GARN.OKASTIH KLJUČEVA 6-32MM, 12PCS, FULLY POLISHED		5803,00

Index / Indeks	Tyła klucza / Type spanner / Тип ящика	Rozmiar / Size / Размер		
C6347		6, 7, 8, 9, 10, 11, 12, 13, 14, 15, 16, 17, 18, 19, 20, 21, 22, 23, 24, 26, 27, 28, 30, 32 mm	1	2
		6x7, 8x9, 10x11, 12x13, 14x15, 16x17, 18x19, 20x22 mm		
		6x8, 10x12, 14x18, 20x24 mm		
		8x10, 9x11, 10x12, 13x14, 15x17, 16x18 mm		
		10x11, 12x13, 14x15, 16x17, 18x19 mm		



C6347	KLJUČEVI SET 47 PCS		16833,00
-------	---------------------	--	----------

Klucz wskowy TORX, polerowany / TORX wrench, fully polished / Ключ накидной TORX, полированный  
 Klucze ozębkowe TORX, polerowane, E6-E24, 4 elem. / Double TORX wrenches, fully polished, E6-E24, 4 pcs / Ключи накатной TORX, полированные E6-E24, 4 шт.  
 Klucze do przewołów hamulcowych, polerowane, 8-18 mm, 6 elem. / Flare nut spanners, fully polished, 8-18 mm, 6 pcs / Ключи разрезные двусторонней, полированные, 8-18 мм, 6 шт.  
 Klucze do pomp i rozruszników, polerowane, 10-19 mm, 5 elem. / C-type spanners, fully polished, 10-19 mm, 5 pcs / Ключи и носовые и стартеры, полированные, 10-19 мм, 5 шт.

C6106	SINGLE TORX KLJUČ E6-E8 MM		168,00
C6110	SINGLE TORX KLJUČ E10-E12 MM		188,00
C6114	SINGLE TORX KLJUČ E14-E18 MM		332,00
C6120	SINGLE TORX KLJUČ E20-E24 MM		505,00
C6104	GARN.TORX KLUČEVA E6-E24, 4 PCS		1266,00
C6406	GAR. OTVORENIH OK- KLJUČEVA 8-18MM, 6PCS		2478,00
C6206	GAR. SEC KLJUČEVA 10-19MM, 5 PCS		2579,00





C7440	FLEK OKASTO/VILJUSKASTI KLJUČ SA KRCKALICOM, 10MM		480,00
C7443	FLEKSIBILNI OKASTO/VILJUSKASTI KLJUČ SA KRCKALICOM, 13MM		620,00
C7447	FLEKSIBILNI OKASTO/VILJUSKASTI KLJUČ SA KRCKALICOM, 17MM		820,00
C7449	FLEKSIBILNI OKASTO/VILJUSKASTI KLJUČ SA KRCKALICOM, 19MM		900,00
C6740	L-TYPE CEVASTI KLJUČEVI GAR. 8-19MM, 5 PCS		2020,00
C6060	CEVASTI KLJUČEVI GAR. 6-22MM		1199,00

Klucze do filtra oleju / Oil filter wrench / Ключ для масляного фильтра, накатной  
 Klucze do filtra oleju, lanchowawy / Oil filter wrench / Ключ для масляного фильтра, цепной  
 Krzywak do kół / Wheel wrench / Ключ для колес  
 Lom budowlany z wyciągaczem / Pry bar with puller / Лом газодер

B2302	OIL FILTER KLJUČ KOŽŃNI 55-150 MM 12'		625,00
B2304	OIL FILTER KLJUČ LANAC 55-150 MM 12'		615,00

C6783	KLJUČ ZA TOČKOVE 17x19x21x1/2'		1599,00
-------	--------------------------------	--	---------

C5880	PAJSER 600MM		1072,00	
C4051	KLJUČ ZA OPRUGE 380 MM 2 PCS		1989,00	
<b>INBUS KLJUČEVI I GARNITURE</b>				
C6641	INBUS KLJUČ 2,5 MM C.V.		24,00	
C6642	INBUS KLJUČ 2 MM C.V.		24,00	
C6643	INBUS KLJUČ 3 MM C.V.		25,00	
C6644	INBUS KLJUČ 4 MM C.V.		25,00	
C6645	INBUS KLJUČ 5 MM C.V.		30,00	
C6646	INBUS KLJUČ 6 MM C.V.		43,00	
C6647	INBUS KLJUČ 7 MM C.V.		58,00	
C6648	INBUS KLJUČ 8 MM C.V.		77,00	
C6649	INBUS KLJUČ 9 MM C.V.		102,00	
C6650	INBUS KLJUČ 10 MM C.V.		133,00	
C6651	INBUS KLJUČ 11 MM C.V.		183,00	
C6652	INBUS KLJUČ 12 MM C.V.		198,00	
C6653	INBUS KLJUČ 13 MM C.V.		282,00	
C6654	INBUS KLJUČ 14 MM C.V.		307,00	
C6657	INBUS KLJUČ 17 MM C.V.		527,00	
C6659	INBUS KLJUČ 19 MM C.V.		688,00	
C6662	INBUS KLJUČ 22 MM C.V.		1038,00	
C6664	INBUS KLJUČ 24 MM C.V.		1185,00	
C6613	GARN.INBUS TORX KLJUČEVA T10-T50, DUGI, 9 PCS			568,00
C6614	GARN.INBUS KLJUČEVA 1,5-10MM, DUGI, 9 PCS			529,00

Ściągacz do łożysk dwuramienny  
Over puller two-armed



Model	Waga	Wysokość	Wysokość
C4055	2770	100	100
C4056	3270	150	150
C4057	3770	200	200



Ściągacz do łożysk trójramienny  
Over puller three-armed



Model	Waga	Wysokość	Wysokość
C4058	2770	100	100
C4059	3270	150	150
C4060	3770	200	200



Ściągacz do łożysk dwuramienny, skrećany  
Gear puller two-armed



Model	Waga	Wysokość	Wysokość
C4061	2700	100	100
C4062	3200	150	150
C4063	3700	200	200
C4064	4200	250	250



Ściągacz do łożysk wewnętrznych, trójramienny  
Internal gear puller three-armed







Model	Waga	Wysokość	Wysokość
C4065	3200	150	150
C4066	3700	200	200
C4067	4200	250	250



Ściągacz do łożysk wewnętrznych, trójramienny

C4055	RADAPCIGER DVOKRAKI 3' (75 MM) CR-V	898,00
C4056	RADAPCIGER DVOKRAKI 4' (100 MM) CR-V	1338,00
C4057	RADAPCIGER DVOKRAKI 6' (150 MM) CR-V	2673,00
C4059	RADAPCIGER TROKRAKI 3' (75 MM) CR-V	1175,00
C4060	RADAPCIGER TROKRAKI 4' (100 MM) CR-V	1888,00
C4061	RADAPCIGER TROKRAKI 6' (150 MM) CR-V	3498,00

C4066	RADAPCIGER DVOKRAKI 2-ARM 2' (35x45 MM)	698,00
C4067	RADAPCIGER DVOKRAKI 2-ARM 3' (38x65 MM)	755,00
C4068	RADAPCIGER DVOKRAKI 2-ARM 4' (40x80 MM)	841,00
C4069	RADAPCIGER DVOKRAKI 2-ARM 6' (55x90 MM)	999,00

C4071	RADAPCIGER DVOKRAKI INTERNAL 3-ARM 12-38 MM	2183,00												
<p>Redukcja 6 elem. / Adapters, 6 pcs / Набор 6 редукции</p> <p>Redukcja 12 elem. / Adapters, 12 pcs / Набор 12 редукции</p> <p>Wkrętak do nasadek 1/4" / Driving handle 1/4" / Отвертка для головок 1/4"</p> <p>Adapter do wkrętarki / Cordless adapter / Адаптер для шуруповерта</p>														
   														
<table border="1"> <tr> <th>Model</th> <th>Waga</th> <th>Wysokość</th> <th>Wysokość</th> </tr> <tr> <td>C4411</td> <td>1000</td> <td>100</td> <td>100</td> </tr> <tr> <td>C4412</td> <td>1200</td> <td>150</td> <td>150</td> </tr> </table>			Model	Waga	Wysokość	Wysokość	C4411	1000	100	100	C4412	1200	150	150
Model	Waga	Wysokość	Wysokość											
C4411	1000	100	100											
C4412	1200	150	150											
C4411	ADAPTERS SET 6 PCS C.V.	2170,00												
C4412	ADAPTERS SET 12 PCS C.V.	2874,00												
C2120	RUČKA OBICNA 1/4'	277,00												
C4417	ADAPTER 1/4' x 1/4' EXCLUSIVE 10 PCS/BOX	69,00												



C4419	ADAPTER 1/2' x 1/4' EXCLUSIVE 4 PCS/BOX		180,00
H2408	NASADNI KLJUČ UNIVERZALNI 1/2' 8 MM TORX E10		200,00
H2409	NASADNI KLJUČ UNIVERZALNI 1/2' 9 MM TORX E11		200,00
H2410	NASADNI KLJUČ UNIVERZALNI 1/2' 10 MM TORX E12		205,00
H2411	NASADNI KLJUČ UNIVERZALNI 1/2' 11 MM TORX E13		205,00
H2412	NASADNI KLJUČ UNIVERZALNI 1/2' 12 MM TORX E14		210,00
H2413	NASADNI KLJUČ UNIVERZALNI 1/2' 13 MM TORX E15		210,00
H2414	NASADNI KLJUČ UNIVERZALNI 1/2' 14 MM TORX E16		220,00
H2415	NASADNI KLJUČ UNIVERZALNI 1/2' 15 MM TORX E17		220,00
H2416	NASADNI KLJUČ UNIVERZALNI 1/2' 16 MM TORX E20		230,00
H2417	NASADNI KLJUČ UNIVERZALNI 1/2' 17 MM TORX E20		230,00
H2418	NASADNI KLJUČ UNIVERZALNI 1/2' 18 MM TORX E22		245,00
H2419	NASADNI KLJUČ UNIVERZALNI 1/2' 19 MM TORX E24		245,00
H2420	NASADNI KLJUČ UNIVERZALNI 1/2' 20 MM		265,00
H2421	NASADNI KLJUČ UNIVERZALNI 1/2' 21 MM TORX E26		295,00
H2422	NASADNI KLJUČ UNIVERZALNI 1/2' 22 MM TORX E28		300,00
H2423	NASADNI KLJUČ UNIVERZALNI 1/2' 23 MM		325,00
H2424	NASADNI KLJUČ UNIVERZALNI 1/2' 24 MM TORX E30		350,00
H2425	NASADNI KLJUČ UNIVERZALNI 1/2' 25 MM		350,00
H2426	NASADNI KLJUČ UNIVERZALNI 1/2' 26 MM		350,00
H2427	NASADNI KLJUČ UNIVERZALNI 1/2' 27 MM TORX E34		520,00
H2428	NASADNI KLJUČ UNIVERZALNI 1/2' 28 MM		520,00
H2429	NASADNI KLJUČ UNIVERZALNI 1/2' 29 MM		605,00
H2430	NASADNI KLJUČ UNIVERZALNI 1/2' 30 MM TORX E38		615,00
H2432	NASADNI KLJUČ UNIVERZALNI 1/2' 32 MM TORX E40		655,00



C4075	PRODUŻETAK GEDORE 1/2' 75MM		220,00
C4125	PRODUŻETAK GEDORE 1/2' 125MM		280,00
C4200	PRODUŻETAK GEDORE 1/2' 200MM		420,00
C4250	PRODUŻETAK GEDORE 1/2' 250MM		430,00



C4422	FLEXIBILNI PRODUŻETAK GEDORE 1/2' 200MM		622,00
C4251	PRODUŻETAK GEDORE "T" BAR 1/2' 250MM		522,00
C4301	L-BAR 1,2' 250MM		542,00

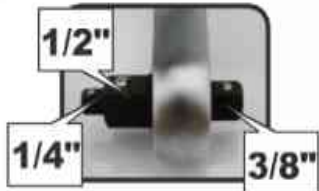

C8416	RUĆICA GEDORE 3 IN 1 1/2', 3/8', 1/4' 60 TEETH, BOX		2970,00
C8430	RUĆICA GEDORE 1/4' 72TEETH CORONA		992,00
C8431	RUĆICA GEDORE 3/8' 72TEETH CORONA		1272,00
C8432	RUĆICA GEDORE 1/2' 72TEETH CORONA		1620,00

Zestaw nasadek 4-13 mm, 1/4", 11 elementów / Socket set 4-13 mm, 1/4", 11 pcs



Zestaw nasadek 1/4", 27 elementów / Socket set 1/4", 27 pcs



Zestaw nasadek 1/4", 43 elementów / Socket set 1/4", 43 pcs / Набор sockets, 1/4", 43 шт.



rozmiar	ilość
4	1
4,5	1
5	1
5,5	1
6	1
7	1
8	1
9	1
10	1
11	1
13	1

rozmiar	ilość
4	1
5	1
6	1
7	1
8	1
9	1
10	1
11	1
12	1
13	1
14	1
15	1
16	1
17	1
18	1
19	1
20	1
21	1
22	1
23	1
24	1
25	1
26	1
27	1

rozmiar	ilość
4	1
5	1
6	1
7	1
8	1
9	1
10	1
11	1
12	1
13	1
14	1
15	1
16	1
17	1
18	1
19	1
20	1
21	1
22	1
23	1
24	1
25	1
26	1
27	1
28	1
29	1
30	1
32	1

C1111	11 PCS GEDORE SET 1/4'		940,00
C1127	GEDORE SET 1/4', 27 PCS		2329,00
C1143	GEDORE SET 1/4', 43 PCS		4044,00

Zestaw nasadek TORX E10-E24, 1/2" / TORX socket set E10-E24, 1/2"

Zestaw nasadek 10 - 24 mm, 1/2" / Socket set 10-24 mm, 1/2"

**Набор головок TORX E10-E24, 1/2"**

Index / Индекс	Wykres / Рисунки (шт.) / Drawing	mm	шт.
<b>C4009</b>	10	5	20
	11		
	12		
	13		
	14		
	15		
	16		
	17		
	18		
	19		

**Набор головок 10 - 24 мм, 1/2"**

Index / Индекс	Wykres / Рисунки (шт.) / Drawing	mm	шт.
<b>C4010</b>	10	5	20
	11		
	12		
	13		
	14		
	15		
	16		
	17		
	18		
	19		

C4009 TORX GEDORE SET 310-E24, 1/2', 9 PCS **1792,00**

C4010 GEDORE SET 10-24MM, 1/2', 10 PCS **1772,00**

**Zestaw narzędzi 94 elem. / Socket set, 94 pcs / Набор инструментов, 94 шт.**

Index / Индекс	Wykres / Рисунки (шт.) / Drawing	mm	шт.
<b>C4594</b>	10	3	94
	11		
	12		
	13		
	14		
	15		
	16		
	17		
	18		
	19		

C4594 GEDORE SET, 94 PCS **11027,00**

**Zestaw narzędzi 150 elem. / Socket set, 150 pcs / Набор инструментов, 150 шт.**

Index / Индекс	Wykres / Рисунки (шт.) / Drawing	mm	шт.
<b>C4550</b>	10	2	150
	11		
	12		
	13		
	14		
	15		
	16		
	17		
	18		
	19		

C4550 GEDORE SET 150 PCS **16503,00**

**Zestaw narzędzi 3/4", 18 elem. / Socket set, 3/4", 18 pcs / Набор инструментов, 3/4", 18 шт.**

Index / Индекс	Wykres / Рисунки (шт.) / Drawing	mm	шт.
<b>C1701</b>	22	1	1
	24		
	27		
	30		
	32		
	35		
	38		
	41		
	48		
	55		

C1701 GEDORE SET 22-65 MM, 3/4' 18 PCS. **27780,00**

**Zestaw nasadek uderowych 10-30 mm, 1/2"**  
**/ Impact socket set 10-30 mm, 1/2"**  
**/ Набор головок ударных 10-30 мм, 1/2"**

Index / Индекс	Kształt / Size (mm) / Размер (мм)	mm	шт.
<b>C4021</b>	10	1	15
	11		
	12		
	13		
	14		
	16		
	17		
	19		
	21		
	22		

**Zestaw nasadek uderowych długich 10-30mm, 1/2"**  
**/ Deep impact socket set 10-30 mm, 1/2"**  
**/ Набор головок ударных длинных 10-30мм, 1/2"**

Index / Индекс	Kształt / Size (mm) / Размер (мм)	mm	шт.
<b>C4027</b>	10	1	10
	11		
	12		
	13		
	14		
	16		
	17		
	19		
	21		
	22		

C4021 IMPACT GEDORE SET 10-30MM, 1/2', 13 PCS, EXCLUSIVE **3793,00**

C4027 DUBOKE IMPACT GEDORE SET 10-30MM, 1/2', 13 PCS, EXCLUSIVE **7642,00**





Model	Opis (nazwa) / Opis	Strona
C4034	Nasadki udarowe Impact socket 1/2" 16, 17, 19, 22, 24, 27, 30, 32, 34, 36 mm Produkte udarowa Impact socket set 1/2" 17, 19, 22 mm Детали удара Impact socket 1/2"	1/4

Model	Opis (nazwa) / Opis	Strona
C4035	W zestawie / In the set SPECIAL TORX, TAG, T70, T80, T90, T100 Nasadki/sockets E 18, E22, E22, E24 IMBUS/HEX, HEX, HEX, HEX, HEX Uchwyty/Handles 3/4", 1" Wtyki/pins/Hex 4 mm	1/2

C4034	SPECIAL IMPACT GEDORE SET 1/2' 22 PCS EXCLUSIVE	12637,00
C4035	TORX, IMBUS IMPACT SET 3/4' , 1' 16 PCS EXCLUSIVE	14125,00

Nasadka 1/2" udarowa  
Impact socket 1/2"



Model	Opis (nazwa) / Opis	Strona
C1809	8 16/100 C1814 22 16/100	
C1811	10 16/100 C1815 24 16/100	
C1814	12 16/100 C1816 26 16/100	
C1816	14 16/100 C1817 28 16/100	
C1819	18 16/100 C1818 27 16/100	
C1807	16 16/100 C1820 28 16/100	
C1808	16 16/100 C1821 29 16/100	
C1809	17 16/100 C1822 30 16/100	
C1810	18 16/100 C1823 32 6/8	
C1813	18 16/100 C1825 34 6/8	
C1812	20 16/100 C1819 36 6/8	
C1819	27 16/100	

Nasadka 1/2" udarowa, dluga  
Impact socket 1/2" steel



Model	Opis (nazwa) / Opis	Strona
C2809	8 16/100 C2814 22 16/100	
C2811	10 16/100 C2815 24 16/100	
C2814	12 16/100 C2817 26 16/100	
C2816	14 16/100 C2819 27 16/100	
C2807	16 16/100 C2820 28 16/100	
C2808	16 16/100 C2821 29 16/100	
C2809	17 16/100 C2822 30 16/100	
C2810	18 16/100 C2823 32 6/8	
C2813	18 16/100 C2825 34 6/8	
C2812	20 16/100 C2819 36 6/8	
C2819	27 16/100	

C1809	NASADNI IMPACT KLJUČ 1/2' 17 MM	315,00
C1811	NASADNI IMPACT KLJUČ 1/2' 19 MM	346,00
C1814	NASADNI IMPACT KLJUČ 1/2' 22 MM	429,00
C1816	NASADNI IMPACT KLJUČ 1/2' 24 MM	465,00
C1819	NASADNI IMPACT KLJUČ 1/2' 27 MM	555,00

C2809	NASADNI DUBOKI IMPACT KLJUČ 1/2' 17 MM	562,00
C2811	ASADNI DUBOKI IMPACT KLJUČ 1/2' 19 MM	585,00
C2814	ASADNI DUBOKI IMPACT KLJUČ 1/2' 22 MM	717,00
C2816	ASADNI DUBOKI IMPACT KLJUČ 1/2' 24 MM	773,00
C2819	ASADNI DUBOKI IMPACT KLJUČ 1/2' 27 MM	810,00

Łącznik Cardana udarowe, przegubowe  
Impact Cardan joint



Redukcja udarowa 2-elementowa 3/4" x 1/2"  
Impact adaptor 2-elements 3/4" x 1/2"



C4440	IMPACT UNIVERZALNI ZGLOB 1/2' CR-MO	1190,00
C4438	IMPACT ADAPTER 2-ELEMENTS 3/4 x 1/2 CR-MO	1012,00



C6950	IMPACT TORX BIT GEDORE SET T30-T80, 1/2', 8 PCS, EXCLUSIVE	4628,00
C6951	IMPACT INBUS BIT GEDORE SET H5-H19, 1/2', 8 PCS, EXCLUSIVE	4710,00
C6952	IMPACT SPLINE BIT GEDORE SET M5-M18, 1/2', 8PCS, EXCLUSIVE	4710,00
C6953	IMPACT RIBE BIT GEDORE SET M5-M18, 1/2', 8 PCS, EXCLUSIVE	4713,00



C6950	IMPACT TORX BIT GEDORE SET T30-T80, 1/2', 8 PCS, EXCLUSIVE	4628,00
-------	--	---------

C6937	TORX SET T20-T70, S2, 22 PCS, EXCLUSIVE	1770,00
C6939	INBUS SET 4-14MM, S2, 22 PCS, EXCLUSIVE	1770,00
C6936	RIBE SET, M4-M18, S2, 22 PCS, EXCLUSIVE	2165,00

bitów SPLINE M4-M18 / SPLINE set M4-M18 / Ключи внутренние SPLINE M4-M18 Zestaw bitów 40 elem. / Bit set / Набор биток







Indeks / Индекс	Rozmiar / Size (mm) / Размер (мм)	шт.	шт.
C6938	30x3 / 30x3 / 10 mm x 30 mm M4-M18, M4, M6, M8, M10, M12, M14 M18 (z charakterystycznym kształtem)	1	20

Indeks / Индекс	Rozmiar / Size (mm) / Размер (мм)	шт.	шт.
C6940	30x3 / 30x3 / 10 mm x 30 mm TORX: T10, T15, T20, T25, T30, T40, T45, T50, T60, T70 SPLINE: S4, S6, S8, S10, S12, S14 S16, S18, S20, S22, S24, S26, S28, S30, S32, S34, S36, S38, S40, S42, S44, S46, S48, S50, S52, S54, S56, S58, S60, S62, S64, S66, S68, S70, S72, S74, S76, S78, S80, S82, S84, S86, S88, S90, S92, S94, S96, S98, S100	1	10

C6938	SPLINE SET M4-M18, S2, 22 PCS, EXCLUSIVE	2200,00
C6940	BIT SET, S2, 40 PCS, EXCLUSIVE	2988,00

Bit TORX / Bit TORX / Бит TORX









Indeks / Индекс	Rozmiar / Size (mm) / Размер (мм)	шт.	шт.
C3200	10x30	5	50
C3201	15x30	5	50
C3202	20x30	5	50
C3203	25x30	5	50
C3204	27x30	5	50
C3205	30x30	5	50
C3206	35x30	5	50
C3207	40x30	5	50
C3208	45x30	5	50
C3209	50x30	5	50
C3210	55x30	5	50
C3211	60x30	5	50
C3212	70x30	5	50

UWAGA !!! Szczegółowe informacje w instrukcji opakowania  
 WARNING !!! See also only in full packages  
 ВНИМАНИЕ !!! Подробная информация в инструкции к упаковке

Bit TORX z otworem / Bit TORX with a hole / Бит TORX с отверстием

Indeks / Индекс	Rozmiar / Size (mm) / Размер (мм)	шт.	шт.
C3220	10x30	5	50
C3221	15x30	5	50
C3222	20x30	5	50
C3223	25x30	5	50
C3224	27x30	5	50
C3225	30x30	5	50
C3226	35x30	5	50
C3227	40x30	5	50
C3228	45x30	5	50
C3229	50x30	5	50
C3230	55x30	5	50
C3231	60x30	5	50
C3232	70x30	5	50

UWAGA !!! Szczegółowe informacje w instrukcji opakowania  
 WARNING !!! See also only in full packages  
 ВНИМАНИЕ !!! Подробная информация в инструкции к упаковке

Bit SPLINE / Bit SPLINE / Бит SPLINE





Indeks / Индекс	Rozmiar / Size (mm) / Размер (мм)	шт.	шт.
C3240	4x30	5	50
C3241	5x30	5	50
C3242	6x30	5	50
C3243	8x30	5	50
C3249	9x30	5	50
C3244	10x30	5	50
C3245	12x30	5	50
C3246	14x30	5	50
C3247	16x30 z otworem	5	50
C3248	18x30 z otworem	5	50

UWAGA !!! Szczegółowe informacje w instrukcji opakowania  
 WARNING !!! See also only in full packages  
 ВНИМАНИЕ !!! Подробная информация в инструкции к упаковке

Bit RIBE / Bit RIBE / Бит RIBE





Indeks / Индекс	Rozmiar / Size (mm) / Размер (мм)	шт.	шт.
C3260	4x30	5	50
C3261	5x30	5	50
C3262	6x30	5	50
C3263	8x30	5	50
C3269	9x30	5	50
C3264	10x30	5	50
C3265	12x30	5	50
C3266	14x30	5	50

UWAGA !!! Szczegółowe informacje w instrukcji opakowania  
 WARNING !!! See also only in full packages  
 ВНИМАНИЕ !!! Подробная информация в инструкции к упаковке



C3267	BIT 10MM RIBE 16x30MM "EXCLUSIVE" S2	136,00
C3268	BIT 10MM RIBE 18x30MM "EXCLUSIVE" S2	168,00

C3250	BIT 10MM IMBUS 4x30MM "EXCLUSIVE" S2	71,00
C3251	BIT 10MM IMBUS 5x30MM "EXCLUSIVE" S2	71,00
C3252	BIT 10MM IMBUS 6x30MM "EXCLUSIVE" S2	71,00
C3254	BIT 10MM IMBUS 8x30MM "EXCLUSIVE" S2	71,00
C3255	BIT 10MM IMBUS 10x30MM "EXCLUSIVE" S2	71,00
C3256	BIT 10MM IMBUS 12x30MM "EXCLUSIVE" S2	87,00
C3257	BIT 10MM IMBUS 14x30MM "EXCLUSIVE" S2	106,00
C3258	BIT 10MM IMBUS 17x30MM "EXCLUSIVE" S2	163,00

Bit IMBUS / Bit HEX / Бит IMBUS

10 (mm) 30 (Lmm)

S2 STEEL

EXCLUSIVE

Uchwyt do bitów / Bit holder / Держатель для битов

Cr-V

Index / Индекс	Wzrost / Wysokość / Размер / Высота	Ø	L
C3250	4x30	5	50
C3251	5x30	5	50
C3252	6x30	5	50
C3253	7x30	5	50
C3254	8x30	5	50
C3255	10x30	5	50
C3256	12x30	5	50
C3257	14x30	5	50
C3258	17x30	5	50

C4416	BIT 10MM HOLDER 1/2'	225,00
-------	----------------------	--------

C6560	BIT INBUS 4x25MM "EXCLUSIVE" S2	25,00
C6561	BIT INBUS 5x25MM "EXCLUSIVE" S2	25,00
C6562	BIT INBUS 6x25MM "EXCLUSIVE" S2	25,00
C6563	BIT INBUS 7x25MM "EXCLUSIVE" S2	35,00
C6564	BIT INBUS 8x25MM "EXCLUSIVE" S2	35,00

Grot PH-2 / Bit PH-2 / Бит с ограничителем

Uchwyt do bitów / Bit holder / Держатель для битов

Uchwyt do bitów, długi / Long bit holder / Держатель для битов, длинный

Uchwyt do bitów automatyczny / Automatic bit holder / Держатель для битов автоматический

Cr-V

Index / Индекс	L (mm)	Ø	Wzrost / Wysokość / Размер / Высота
C6586	60	1/4"	60
C6587	80	1/4"	80
C6588	120	1/4"	120

C6556	BIT PH 2x200MM "EXCLUSIVE" S2-ACR	250,00
C6558	BIT PH 2x250MM "EXCLUSIVE" S2-ACR	330,00
C6580	KNAUF BIT PH 2x25MM "EXCLUSIVE" S2	95,00
C6581	DRZAC BITA 60MM MAGNETIC "EXCLUSIVE"	185,00
C6582	DRZAC BITA 150MM MAGNET.	225,00
C6585	AUTOMATIC DRZAC BITA 60MM MAGNETIC "EXCLUSIVE"	433,00

Uchwyt do grotów udarowych / Impact bit holder

Uchwyt do grotów z tuleją / Bit holder with extension tube

Uchwyt do grotów z tuleją / Bit holder with extension tube

Cr-V

Index / Индекс	L (mm)	Ø	Wzrost / Wysokość / Размер / Высота
C6586	60	1/4"	60
C6587	80	1/4"	80
C6588	120	1/4"	120

C6586	IMPACT DRZAČ BITA 60MM MAGNETIC	275,00
C6587	DRZAČ BITA SA GRANIČNIKOM DUBINE 80MM MAGNETIC	225,00
C6588	DRZAČ BITA SA GRANIČNIKOM DUBINE 120MM MAGNETIC	275,00

Nasadki magnetyczne do wkrętów typu farmer / Magnetic nut setter / Гайковок магнитная

Cr-V

Index / Индекс	L (mm)	Ø	Wzrost / Wysokość / Размер / Высота
C2449	7	7	55,00
C2450	8	8	55,00
C2451	10	10	55,00
C2452	13	13	67,00

C2437	IMPACT MAGNETIC NUT SETTER 8MM x 65MM	152,00
C2438	IMPACT MAGNETIC NUT SETTER 10MM x 65MM	174,00

C2439	IMPACT MAGNETIC NUT SETTER 13MM x 65MM	230,00
-------	--	--------

Wiertło diamentowe  
Diamond drill bit



Typ	Wielkość	Waga
C8930	6	50/500
C8931	8	50/500
C8932	10	50/500
C8933	12	50/500

C8930	DIJAMANTSKA BURGIIJA 6mm	182,00
C8931	DIJAMANTSKA BURGIIJA 8mm	208,00
C8932	DIJAMANTSKA BURGIIJA 10mm	228,00
C8933	DIJAMANTSKA BURGIIJA 12mm	248,00

Wkrętaki MINI, 48 grotów

MINI screwdriver, 48 bits



Zestaw grotów 17 elem. / 17 pcs bits set

/ Набор битов 17 шт.



Index	Typ / type	Rozmiar / size	Waga / weight
C5368	PH000, PH00, PH0, PH1	T2, T3, T4, T5, T6, T7	10/60
	T8H, T9H, T10H, T15H, T20H	1.0, 1.5, 2.0, 2.5, 3.0, 3.5, 4.0	
	U2 & UH 0		
	H0.7, H0.9, H1.3, H1.5, H2.0, H2.5, H3.0, H3.5, H4.0	2.0, 2.5, 3.0	
		0.8	
		2.5	
		Y0.6, Y1, Y2.0, Y2.5	
		S0, S1, S2	
		0.8, 1.2, 1.5	
		Uchwyt do grotów / bit holder	



Index	Typ / type	Rozmiar / size	Waga / weight
C6590	BIT GARNITURA 17 PCS "EXCLUSIVE" S2-ACR		1 40

C5368	GARN. MINI ODVIJAČA + 48 BITS	2393,00
C6590	BIT GARNITURA 17 PCS "EXCLUSIVE" S2-ACR	983,00

Zestaw grotów 45 elementów  
Bits set 45 pcs



Wkrętak z grzechotką + grot 57 elementów  
Screwdriver with ratchet + bits 57 pcs



Index	Typ / type	Zbiór / set	Słowa / words	Waga / weight
C6515	PH1, PH2, PH3, PH4	PH1, PH2, PH3, PH4, PH5, PH6, PH7	PZ2	6/24
	S2, S2.5, S3	S4		
	H2, H4, H5, H6, H8			
	T15, T20, T25, T27, T30, T40	T15, T20, T25, T27, T30, T35, T40		
	S1, S2, S3	S2		
		PH2 x 7mm		



Index	Typ / type	Zbiór / set	Słowa / words	Waga / weight
C5369	PH0, PH1, PH2, PH3, PH4	PH0, PH1, PH2, PH3, PH4, PH5, PH6, PH7, PH8	PZ2	6/24
	S2, S2.5, S3	S4		
	H2, H4, H5, H6, H8			
	T15, T20, T25, T27, T30, T40	T15, T20, T25, T27, T30, T35, T40		
	S1, S2, S3	S2		
		PH2 x 7mm		
		Y0.6, Y1, Y2.0, Y2.5		
		S0, S1, S2		
		0.8, 1.2, 1.5		
		Uchwyt do grotów / bit holder		

C6515	BIT GARNITURA 45 PCS S2	2065,00
C5369	BIT GARNITURA SA RUČKOM + BITS S2, 57 PCS	2620,00

**Wiertła do metalu 1,5-6,5 mm**  
Drills for metal 1,5-6,5 mm  
Сверла по металлу 1,5-6,5 мм

C9400 1 100

**Wiertła do metalu 1-10 mm**  
Drills for metal 1-10 mm  
Сверла по металлу 1-10 мм

C9405 1 20



**Wiertło do konfirmatów / Special wood drill**  
Сверло срединное по дереву

C3398 1 10

C9400	HSS-G BURGIIJA SET 1,5-6,5 MM 13 PCS PLASTIC BOX	367,00
C9405	HSS-G BURGIIJA SET 1-10 MM 19 PCS METAL BOX	1280,00
C9406	HSS-G BURGIIJA SET 1-13 MM 25 PCS METAL BOX	2568,00
C3398	SPECIAL BURGIIJA ZA DRVO 6,4 MM	615,00
C3399	SPECIAL BURGIIJA ZA DRVO, 7 MM PL	615,00
XT35015	HSS COBALT BURGIIJA SET 1,5-10MM	3222,00

C9039	MERAČ NAVOJA 52 PCS 0,25 - 6 MM, 4 - 62 INCI	850,00
-------	--	--------



C9000	NOSAČ UREZNICA M1-M12			370,00
C9001	NOSAČ UREZNICA M5-M20			1756,00
C9002	NOSAČ UREZNICA M5-M12		<b>C9002 M5-M12 10 40</b>	1190,00

C9003	UREZNIK-RUČNI DIN352 M3	<b>Gwintownik, 3 szt. / Tap, 3 pcs / Метчик, 3 шт.</b>		272,00																																																
C9004	UREZNIK-RUČNI DIN352 M4		<table border="1"> <thead> <tr> <th>Index / Индекс</th> <th>Rozmiar / Size (mm) / Размер (мм)</th> <th>10</th> <th>100</th> </tr> </thead> <tbody> <tr><td>C9003</td><td>M3 x 0,5</td><td>10</td><td>500</td></tr> <tr><td>C9004</td><td>M4 x 0,7</td><td>10</td><td>500</td></tr> <tr><td>C9005</td><td>M5 x 0,8</td><td>10</td><td>600</td></tr> <tr><td>C9006</td><td>M6 x 1</td><td>10</td><td>600</td></tr> <tr><td>C9008</td><td>M8 x 1,25</td><td>10</td><td>300</td></tr> <tr><td>C9010</td><td>M10 x 1,5</td><td>10</td><td>300</td></tr> <tr><td>C9012</td><td>M12 x 1,75</td><td>10</td><td>150</td></tr> <tr><td>C9014</td><td>M14 x 2</td><td>10</td><td>100</td></tr> <tr><td>C9016</td><td>M16 x 2</td><td>10</td><td>100</td></tr> <tr><td>C9018</td><td>M18 x 2,5</td><td>10</td><td>50</td></tr> <tr><td>C9020</td><td>M20 x 2,5</td><td>10</td><td>50</td></tr> </tbody> </table>	Index / Индекс	Rozmiar / Size (mm) / Размер (мм)	10	100	C9003	M3 x 0,5	10	500	C9004	M4 x 0,7	10	500	C9005	M5 x 0,8	10	600	C9006	M6 x 1	10	600	C9008	M8 x 1,25	10	300	C9010	M10 x 1,5	10	300	C9012	M12 x 1,75	10	150	C9014	M14 x 2	10	100	C9016	M16 x 2	10	100	C9018	M18 x 2,5	10	50	C9020	M20 x 2,5	10	50	272,00
Index / Индекс	Rozmiar / Size (mm) / Размер (мм)			10	100																																															
C9003	M3 x 0,5			10	500																																															
C9004	M4 x 0,7			10	500																																															
C9005	M5 x 0,8			10	600																																															
C9006	M6 x 1			10	600																																															
C9008	M8 x 1,25			10	300																																															
C9010	M10 x 1,5			10	300																																															
C9012	M12 x 1,75			10	150																																															
C9014	M14 x 2			10	100																																															
C9016	M16 x 2	10	100																																																	
C9018	M18 x 2,5	10	50																																																	
C9020	M20 x 2,5	10	50																																																	
C9005	UREZNIK-RUČNI DIN352 M5	272,00																																																		
C9006	UREZNIK-RUČNI DIN352 M6	325,00																																																		
C9008	UREZNIK-RUČNI DIN352 M8	439,00																																																		
C9010	UREZNIK-RUČNI DIN352 M10	485,00																																																		
C9012	UREZNIK-RUČNI DIN352 M12	542,00																																																		
C9014	UREZNIK-RUČNI DIN352 M14	703,00																																																		
C9016	UREZNIK-RUČNI DIN352 M16	807,00																																																		
C9018	UREZNIK-RUČNI DIN352 M18	976,00																																																		
C9020	UREZNIK-RUČNI DIN352 M20	1211,00																																																		

C9021	UREZNIK MAŠINSKI DIN371 M3	<b>Gwintownik maszynowy / Machinist tap / Метчик для станков</b>		385,00																																				
C9022	UREZNIK MAŠINSKI DIN371 M4		<table border="1"> <thead> <tr> <th>Index / Индекс</th> <th>Rozmiar / Size (mm) / Размер (мм)</th> <th>10</th> <th>100</th> </tr> </thead> <tbody> <tr><td>C9021</td><td>M3 x 0,5</td><td>10</td><td>200</td></tr> <tr><td>C9022</td><td>M4 x 0,7</td><td>10</td><td>200</td></tr> <tr><td>C9023</td><td>M5 x 0,8</td><td>10</td><td>200</td></tr> <tr><td>C9024</td><td>M6 x 1</td><td>10</td><td>200</td></tr> <tr><td>C9025</td><td>M7 x 1</td><td>10</td><td>200</td></tr> <tr><td>C9026</td><td>M8 x 1,25</td><td>10</td><td>200</td></tr> <tr><td>C9027</td><td>M10 x 1,5</td><td>10</td><td>200</td></tr> <tr><td>C9028</td><td>M12 x 1,75</td><td>10</td><td>200</td></tr> </tbody> </table>	Index / Индекс	Rozmiar / Size (mm) / Размер (мм)	10	100	C9021	M3 x 0,5	10	200	C9022	M4 x 0,7	10	200	C9023	M5 x 0,8	10	200	C9024	M6 x 1	10	200	C9025	M7 x 1	10	200	C9026	M8 x 1,25	10	200	C9027	M10 x 1,5	10	200	C9028	M12 x 1,75	10	200	392,00
Index / Индекс	Rozmiar / Size (mm) / Размер (мм)			10	100																																			
C9021	M3 x 0,5			10	200																																			
C9022	M4 x 0,7			10	200																																			
C9023	M5 x 0,8			10	200																																			
C9024	M6 x 1			10	200																																			
C9025	M7 x 1			10	200																																			
C9026	M8 x 1,25			10	200																																			
C9027	M10 x 1,5	10	200																																					
C9028	M12 x 1,75	10	200																																					
C9023	UREZNIK MAŠINSKI DIN371 M5	421,00																																						
C9024	UREZNIK MAŠINSKI DIN371 M6	447,00																																						
C9026	UREZNIK MAŠINSKI DIN371 M8	540,00																																						
C9027	UREZNIK MAŠINSKI DIN371 M10	685,00																																						
C9028	UREZNIK MAŠINSKI DIN371 M12	927,00																																						

C8980	UREZNIK MAŠINSK HSS M 3 DIN 371B	<b>Gwintownik maszynowy / Machinist tap</b>		430,00																																				
C8981	UREZNIK MAŠINSK HSS M 4 DIN 371B		<table border="1"> <thead> <tr> <th>Index / Индекс</th> <th>Rozmiar / Size (mm) / Размер (мм)</th> <th>10</th> <th>100</th> </tr> </thead> <tbody> <tr><td>C8980</td><td>M3 x 0,5</td><td>10</td><td>200</td></tr> <tr><td>C8981</td><td>M4 x 0,7</td><td>10</td><td>200</td></tr> <tr><td>C8982</td><td>M5 x 0,8</td><td>10</td><td>200</td></tr> <tr><td>C8983</td><td>M6 x 1</td><td>10</td><td>200</td></tr> <tr><td>C8984</td><td>M7 x 1</td><td>10</td><td>200</td></tr> <tr><td>C8985</td><td>M8 x 1,25</td><td>10</td><td>200</td></tr> <tr><td>C8986</td><td>M10 x 1,5</td><td>10</td><td>200</td></tr> <tr><td>C8987</td><td>M12 x 1,75</td><td>10</td><td>200</td></tr> </tbody> </table>	Index / Индекс	Rozmiar / Size (mm) / Размер (мм)	10	100	C8980	M3 x 0,5	10	200	C8981	M4 x 0,7	10	200	C8982	M5 x 0,8	10	200	C8983	M6 x 1	10	200	C8984	M7 x 1	10	200	C8985	M8 x 1,25	10	200	C8986	M10 x 1,5	10	200	C8987	M12 x 1,75	10	200	440,00
Index / Индекс	Rozmiar / Size (mm) / Размер (мм)			10	100																																			
C8980	M3 x 0,5			10	200																																			
C8981	M4 x 0,7			10	200																																			
C8982	M5 x 0,8			10	200																																			
C8983	M6 x 1			10	200																																			
C8984	M7 x 1			10	200																																			
C8985	M8 x 1,25			10	200																																			
C8986	M10 x 1,5	10	200																																					
C8987	M12 x 1,75	10	200																																					
C8982	UREZNIK MAŠINSK HSS M 5 DIN 371B	470,00																																						
C8983	UREZNIK MAŠINSK HSS M 6 DIN 371B	500,00																																						
C8984	UREZNIK MAŠINSK HSS M 7 DIN 371B	540,00																																						
C8985	UREZNIK MAŠINSK HSS M 8 DIN 371B	605,00																																						
C8986	UREZNIK MAŠINSK HSS M 10 DIN 371B	710,00																																						
C8987	UREZNIK MAŠINSK HSS M 12 DIN 376B	970,00																																						

C8990	UREZNIK MAŠINSK HSS M 3 DIN 371C	<b>Gwintownik maszynowy / Machinist tap</b>		420,00																																				
C8991	UREZNIK MAŠINSK HSS M 4 DIN 371C		<table border="1"> <thead> <tr> <th>Index / Индекс</th> <th>Rozmiar / Size (mm) / Размер (мм)</th> <th>10</th> <th>100</th> </tr> </thead> <tbody> <tr><td>C8990</td><td>M4 x 0,5</td><td>10</td><td>200</td></tr> <tr><td>C8991</td><td>M4 x 0,7</td><td>10</td><td>200</td></tr> <tr><td>C8992</td><td>M5 x 0,8</td><td>10</td><td>200</td></tr> <tr><td>C8993</td><td>M6 x 1</td><td>10</td><td>200</td></tr> <tr><td>C8994</td><td>M7 x 1</td><td>10</td><td>200</td></tr> <tr><td>C8995</td><td>M8 x 1,25</td><td>10</td><td>200</td></tr> <tr><td>C8996</td><td>M10 x 1,5</td><td>10</td><td>200</td></tr> <tr><td>C8997</td><td>M12 x 1,75</td><td>10</td><td>200</td></tr> </tbody> </table>	Index / Индекс	Rozmiar / Size (mm) / Размер (мм)	10	100	C8990	M4 x 0,5	10	200	C8991	M4 x 0,7	10	200	C8992	M5 x 0,8	10	200	C8993	M6 x 1	10	200	C8994	M7 x 1	10	200	C8995	M8 x 1,25	10	200	C8996	M10 x 1,5	10	200	C8997	M12 x 1,75	10	200	480,00
Index / Индекс	Rozmiar / Size (mm) / Размер (мм)			10	100																																			
C8990	M4 x 0,5			10	200																																			
C8991	M4 x 0,7			10	200																																			
C8992	M5 x 0,8			10	200																																			
C8993	M6 x 1			10	200																																			
C8994	M7 x 1			10	200																																			
C8995	M8 x 1,25			10	200																																			
C8996	M10 x 1,5	10	200																																					
C8997	M12 x 1,75	10	200																																					
C8992	UREZNIK MAŠINSK HSS M 5 DIN 371C	520,00																																						
C8993	UREZNIK MAŠINSK HSS M 6 DIN 371C	550,00																																						
C8994	UREZNIK MAŠINSK HSS M 7 DIN 371C	610,00																																						
C8995	UREZNIK MAŠINSK HSS M 8 DIN 371C	670,00																																						
C8996	UREZNIK MAŠINSK HSS M 10 DIN 371C	770,00																																						
C8997	UREZNIK MAŠINSK HSS M 12 DIN 376C	1090,00																																						

C9071	UREZNIK MAŠINSKI M 4x0,5 DIN 2181	<b>Gwintownik drobnozwojowy, 2 szt. / Fine tread tap, 2 pcs / Метчик для тонкой нарезки, 2 шт.</b>		350,00																																																																								
C9072	UREZNIK MAŠINSKI M 5x0,5 DIN 2181		<table border="1"> <thead> <tr> <th>Index / Индекс</th> <th>Rozmiar / Size (mm) / Размер (мм)</th> <th>10</th> <th>100</th> </tr> </thead> <tbody> <tr><td>C9071</td><td>M4 x 0,5</td><td>10</td><td>100</td></tr> <tr><td>C9072</td><td>M5 x 0,5</td><td>10</td><td>100</td></tr> <tr><td>C9073</td><td>M6 x 0,75</td><td>10</td><td>100</td></tr> <tr><td>C9074</td><td>M8 x 0,75</td><td>10</td><td>100</td></tr> <tr><td>C9075</td><td>M8 x 1</td><td>10</td><td>100</td></tr> <tr><td>C9076</td><td>M10 x 0,75</td><td>10</td><td>100</td></tr> <tr><td>C9077</td><td>M10 x 1</td><td>10</td><td>100</td></tr> <tr><td>C9078</td><td>M10 x 1,25</td><td>10</td><td>100</td></tr> <tr><td>C9079</td><td>M12 x 1</td><td>10</td><td>100</td></tr> <tr><td>C9080</td><td>M12 x 1,25</td><td>10</td><td>100</td></tr> <tr><td>C9081</td><td>M12 x 1,5</td><td>10</td><td>100</td></tr> <tr><td>C9082</td><td>M14 x 1</td><td>10</td><td>100</td></tr> <tr><td>C9083</td><td>M14 x 1,25</td><td>10</td><td>100</td></tr> <tr><td>C9084</td><td>M14 x 1,5</td><td>10</td><td>100</td></tr> <tr><td>C9085</td><td>M16 x 1</td><td>10</td><td>100</td></tr> <tr><td>C9086</td><td>M16 x 1,25</td><td>10</td><td>100</td></tr> <tr><td>C9087</td><td>M16 x 1,5</td><td>10</td><td>100</td></tr> </tbody> </table>	Index / Индекс	Rozmiar / Size (mm) / Размер (мм)	10	100	C9071	M4 x 0,5	10	100	C9072	M5 x 0,5	10	100	C9073	M6 x 0,75	10	100	C9074	M8 x 0,75	10	100	C9075	M8 x 1	10	100	C9076	M10 x 0,75	10	100	C9077	M10 x 1	10	100	C9078	M10 x 1,25	10	100	C9079	M12 x 1	10	100	C9080	M12 x 1,25	10	100	C9081	M12 x 1,5	10	100	C9082	M14 x 1	10	100	C9083	M14 x 1,25	10	100	C9084	M14 x 1,5	10	100	C9085	M16 x 1	10	100	C9086	M16 x 1,25	10	100	C9087	M16 x 1,5	10	100	360,00
Index / Индекс	Rozmiar / Size (mm) / Размер (мм)			10	100																																																																							
C9071	M4 x 0,5			10	100																																																																							
C9072	M5 x 0,5			10	100																																																																							
C9073	M6 x 0,75			10	100																																																																							
C9074	M8 x 0,75			10	100																																																																							
C9075	M8 x 1			10	100																																																																							
C9076	M10 x 0,75			10	100																																																																							
C9077	M10 x 1			10	100																																																																							
C9078	M10 x 1,25			10	100																																																																							
C9079	M12 x 1			10	100																																																																							
C9080	M12 x 1,25			10	100																																																																							
C9081	M12 x 1,5			10	100																																																																							
C9082	M14 x 1			10	100																																																																							
C9083	M14 x 1,25			10	100																																																																							
C9084	M14 x 1,5			10	100																																																																							
C9085	M16 x 1	10	100																																																																									
C9086	M16 x 1,25	10	100																																																																									
C9087	M16 x 1,5	10	100																																																																									
C9073	UREZNIK MAŠINSKI M 6x0,75 " DIN 2181	520,00																																																																										
C9074	UREZNIK MAŠINSKI M 8x0,75 DIN 2181	520,00																																																																										
C9075	UREZNIK MAŠINSKI M 8x1 DIN 2181	560,00																																																																										
C9076	UREZNIK MAŠINSKI M 10x0,75 DIN 2181	560,00																																																																										
C9077	UREZNIK MAŠINSKI M 10x1 DIN 2181	560,00																																																																										
C9078	UREZNIK MAŠINSKI M 10x1,25 DIN 2181	640,00																																																																										
C9079	UREZNIK MAŠINSKI M 12x1 DIN 2181	640,00																																																																										
C9080	UREZNIK MAŠINSKI M 12x1,25 DIN 2181	640,00																																																																										
C9081	UREZNIK MAŠINSKI M 12x1,5 " DIN 2181	790,00																																																																										
C9082	UREZNIK MAŠINSKI M 14x1 DIN 2181	790,00																																																																										
C9083	UREZNIK MAŠINSKI M 14x1,25 DIN 2181	790,00																																																																										
C9084	UREZNIK MAŠINSKI M 14x1,5 DIN 2181	790,00																																																																										

C9085	UREZNIK MAŠINSKI M 16x1 DIN 2181	920,00
C9086	UREZNIK MAŠINSKI M 16x1,25 DIN 2181	920,00
C9087	UREZNIK MAŠINSKI M 16x1,5 DIN 2181	920,00

C9041	DRZAČ NAREZNICE 20x7MM M4-M6	Oprawa do narzynki / Die holder / Держатель плашек	330,00
C9042	DRZAČ NAREZNICE 25x9MM M8		370,00
C9043	DRZAČ NAREZNICE 30x11MM M10		660,00
C9044	DRZAČ NAREZNICE 38x14MM M12-M14		890,00
C9045	DRZAČ NAREZNICE 35x18MM M16-M20		1265,00

C9093	NAREZNICA M 8x1 DIN 223	Narzynka drutnarzajowa / Fine thread Die / Плашка для тонкой резьбы	310,00
C9094	NAREZNICA M 10x1,25 DIN 223		360,00
C9095	NAREZNICA M 12x1,5 DIN 223		450,00
C9096	NAREZNICA M 14x1,5 DIN 223		560,00
C9097	NAREZNICA M 16x1,5 DIN 223		670,00

C9053	NAREZNICA M3	DIN 223 Si-Cr	Narzynka / Die / Плашка	250,00
C9054	NAREZNICA M4			250,00
C9055	NAREZNICA M5			250,00
C9056	NAREZNICA M6			250,00
C9058	NAREZNICA M8			285,00
C9060	NAREZNICA M10			285,00
C9062	NAREZNICA M12			455,00
C9064	NAREZNICA M14			500,00
C9066	NAREZNICA M16			680,00
C9068	NAREZNICA M18			715,00
C9070	NAREZNICA M20			815,00

**Zestaw narzynki M3 - M12 z oprawką / Die set / Набор плашек**



Index / Индекс	Narzynka / Die (mm) / Плашка (мм)	Q	Q1
C9180	M3x0,5	10	200
	M4x0,7	10	200
	M5x0,8	10	200
	M6x1	10	200
	M8x1,25	10	200
	M10x1,5	10	200
	M12x1,75	10	200

**Zestaw gwintowników M3-M12 z pokrętkiem / Tap set M3-M12 with tap wrench / Набор метчиков M3-M12 с воротком**



Index / Индекс	Narzynka / Die (mm) / Плашка (мм)	Q	Q1
C9181	M3x0,5	1	24
	M4x0,7		
	M5x0,8		
	M6x1		
	M8x1,25		
	M10x1,5		
	M12x1,75		

**Zestaw gwintowników i narzynki M3 - M12 z pokrętkiem / Tap & die set / Набор метчиков и плашек**



Index / Индекс	Narzynka / Die (mm) / Плашка (мм)	Q	Q1
C9182	M3x0,5	1	10
	M4x0,7		
	M5x0,8		
	M6x1		
	M8x1,25		
	M10x1,5		
	M12x1,75		

C9180	NAREZNICE SET 8PCS EXCLUSIVE	1980,00
C9181	UREZNICE SET 22PCS EXCLUSIVE	3533,00
C9182	UREZNICE I NAREZNICE SET 32 PCS EXCLUSIVE	5382,00
C9183	UREZNICE I NAREZNICE SET M3-M20 55 PCS DIN352	19434,00

**Wykrętki do urywanych śrub M3-M25, 6 elementów / Screw extractor set, 6 pcs**



Index / Индекс	Śruby / Screws (mm)	Q	Q1
C9190	M3-M6	3/8"	1/2"
	M8-M10	1/2"	5/8"
	M12-M14	5/8"	3/4"
	M16-M18	3/4"	1"
	M20-M25	1"	1 1/4"

**Wykrętki do urywanych śrub M3-M50, 8 elementów / Screw extractor set, 8 pcs**



Index / Индекс	Śruby / Screws (mm)	Q	Q1
C9191	M3-M6	3/8"	1/2"
	M8-M10	1/2"	5/8"
	M12-M14	5/8"	3/4"
	M16-M20	3/4"	1"
	M22-M25	1"	1 1/4"
	M28-M30	1 1/4"	1 3/4"
	M32-M36	1 3/4"	2"

**IRWIN BOLT GRIP 3 Piece Expansion Set**



C9190	GARNITURA ZA ODVIJANJE LEVE BURGIIJE 5 PCS M3-M18	390,00
C9191	GARNITURA ZA ODVIJANJE LEVE BURGIIJE 6 PCS M3-M25	620,00
10504635	IRWIN GARN.ZA ODVIJANJE MATICA	2720,00



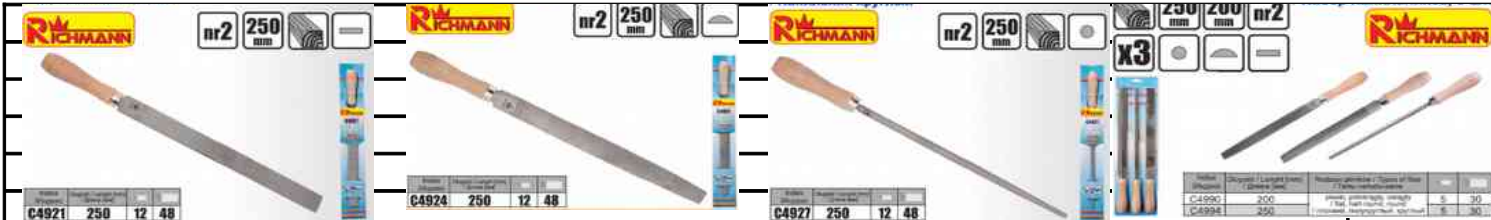

C4921	TURPIJA ZA DRVO RAVNA 250 MM NR 2 WITH HANDLE	363,00
C4924	TURPIJA ZA DRVO POLUOKRUGLA 250 MM NR 2 WITH HANDLE	382,00
C4927	TURPIJA ZA DRVO OKRUGLA 250 MM NR 2 WITH HANDLE	310,00
C4994	TURPIJA ZA METAL SET 3 PCS 250 MM NR 2 WITH HANDLES	1080,00



C4936	TURPIJA ZA METAL RAVNA 250 MM NR 1 WITH HANDLE	373,00
C4937	TURPIJA ZA METAL RAVNA 250 MM NR 2 WITH HANDLE	373,00
C4946	TURPIJA ZA METAL POLUOKRUGLA 250 MM NR 1 WITH HANDLE	420,00
C4947	TURPIJA ZA METAL POLUOKRUGLA 250 MM NR 2 WITH HANDLE	420,00
C4966	TURPIJA ZA METAL OKRUGLA MM NR 1 WITH HANDLE	277,00
C4967	TURPIJA ZA METAL OKRUGLA 250 MM NR 2 WITH HANDLE	277,00
C4956	TURPIJA ZA METAL TROUGLASTA 250 MM NR 1 WITH HANDLE	310,00
C4957	TURPIJA ZA METAL TROUGLASTA 250 MM NR 2 WITH HANDLE	310,00



C8251	KRUNE ZA DRVO,GIPS SET, 19-64MM, 11 PCS	520,00
C8252	KRUNE ZA DRVO,GIPS SET, 19-127MM, 16 PCS	970,00
C8260	KRUNA ZA BETON 65MM	1150,00
C8261	KRUNA ZA BETON 80MM	1350,00
C8262	KRUNA ZA BETON 100MM	1850,00
C8263	KRUNA ZA BETON 120MM	2560,00
C8264	KRUNA ZA BETON 150MM	3680,00
C8258	SDS-MAX NOSAC KRUNE ZA BETON 180 MM	780,00



C5830	IGLA ZA OBELEŽAVANJE 150 MM	256,00
C5810	CENTER KIRNER 6x100MM x 10MM	245,00
C5801	KIRNERI SET 6 PCS	1210,00
C5802	DLETA I KIRNERI SET 12 PCS	2992,00
C5803	DLETA I KIRNERI SET 6 PCS	1450,00
C5805	DLETA I KIRNERI SET, BIG SIZES, 7 PCS	3050,00



C9208	ADAPTOR SDS+	95,00
C9200	FUTER 1/2' 1-10 MM	450,00
C9201	FUTER 1/2' 1,5-13 MM	470,00
C9209	FUTER I ADAPTER SDS 1/2' 1,5-13MM	561,00
C9221	BRZI FUTER 1/2' 2-13MM	235,00
C9222	BRZI FUTER 1/2' 2-13MM, METAL RING	815,00
C4681	GRINDING DIAMOND BRUSNI DISK CUP SEGMENT 125MM	1865,00
C4804	DIAMONT DISC CERAMIKA 115 MM "EXCLUSIVE" SEGMENT HEIGHT 7 MM	402,00
C4805	DIAMONT DISC CERAMIKA 125 MM "EXCLUSIVE" SEGMENT HEIGHT 7 MM	432,00
C4806	DIAMONT DISC CERAMIKA 180 MM "EXCLUSIVE" SEGMENT HEIGHT 7 MM	862,00
C4807	DIAMONT DISC CERAMIKA 230 MM "EXCLUSIVE" SEGMENT HEIGHT 7 MM	1320,00
C4800	DIAMONT DISC SEGMENT 115 MM "EXCLUSIVE" SEGMENT HEIGHT 10 MM	417,00
C4801	DIAMONT DISC SEGMENT 125 MM "EXCLUSIVE" SEGMENT HEIGHT 10 MM	444,00
C4802	DIAMONT DISC SEGMENT 180 MM "EXCLUSIVE" SEGMENT HEIGHT 10 MM	865,00
C4803	DIAMONT DISC SEGMENT 230 MM "EXCLUSIVE" SEGMENT HEIGHT 10 MM	1409,00
C4812	DIAMONT TURBO 115 MM ARMIRANI BETON SEGMENT 10 MM	459,00
C4813	DIAMONT TURBO 125 MM ARMIRANI BETON SEGMENT 10 MM	479,00
C4814	DIAMONT TURBO 180 MM ARMIRANI BETON SEGMENT 10 MM	879,00
C4815	DIAMONT TURBO 230 MM ARMIRANI BETON SEGMENT 10 MM	1506,00
C4860	DIJAMANTSKI DISK ZA SEČENJE I GEROVANJE M14 125x1,6MM	2932,00
C4859	DIJAMANTSKI DISK ZA SEČENJE I GEROVANJE 125x1,3MM	2376,00
C4849	DIJAMANTSKA TRAPEZNA BURGIIJA 38MM M14	3466,00
C4861	DIAMOND DISC CERAMIKA RIM 180x2x25,4/22,23 MM	1603,00
C4862	DIAMOND DISC CERAMIKA THIN 200x2x25,4/22,2 MM "EXCLUSIVE"	1808,00
C4865	DIAMOND DISC CERAMIKA THIN 250x2,2x25,4/22,2 MM "EXCLUSIVE"	2919,00
C4894	DIAMONT DISC 300x25,4 MM FOR BETON SEGMENT HEIGHT 10 MM	8795,00
C4895	DIAMONT DISC 350x25,4 MM FOR BETON SEGMENT HEIGHT 10 MM	10224,00
C4896	DIAMONT DISC 400x25,4 MM FOR BETON SEGMENT HEIGHT 10 MM	13480,00
C4897	DIAMONT DISC 300x25,4 MM FOR ASPHALT SEGMENT HEIGHT 10 MM	10259,00
C4898	DIAMONT DISC 350x25,4 MM FOR ASPHALT SEGMENT HEIGHT 10 MM	11411,00
C4899	DIAMONT DISC 400x25,4 MM FOR ASPHALT SEGMENT HEIGHT 10 MM	14496,00



Przyssawka do szyb podróżna  
Triple glass holder



Przyssawka próżniowa do szyb z manometrem  
Vacuum suction cup manometer



C0490	VAKUMSKI ALUMINIJUMSKI DRŻAČ 123 MM, 50 KG	870,00
C0491	VAKUMSKI ALUMINIJUMSKI DRŻAČ DUPLI 123 MM,120 KG	1750,00
C0492	VAKUMSKI ALUMINIJUMSKI DRŻAČ TRODELNI 123 MM,180 KG	2175,00
C0493	VAKUMSKI DRŻAČ 150 MM, 80 KG, MANOMETER	3145,00
C0494	VAKUMSKI DRŻAČ 200 MM,120 KG, MANOMETER	4428,00

C4816	DIJ.KRUNA ZA BRUSILICU 6MM M14	1605,00
C4817	DIJ.KRUNA ZA BRUSILICU 8MM M14	1605,00
C4818	DIJ.KRUNA ZA BRUSILICU 10MM M14	1672,00
C4819	DIJ.KRUNA ZA BRUSILICU 12MM M14	1735,00
C4822	DIJ.KRUNA ZA BRUSILICU 16MM M14	1868,00
C4824	DIJ.KRUNA ZA BRUSILICU 20MM M14	1873,00
C4826	DIJ.KRUNA ZA BRUSILICU 25MM M14	2302,00
C4829	DIJ.KRUNA ZA BRUSILICU 30MM M14	2720,00
C4831	DIJ.KRUNA ZA BRUSILICU 35MM M14	3147,00
C4834	DIJ.KRUNA ZA BRUSILICU 45MM M14	4044,00
C4835	DIJ.KRUNA ZA BRUSILICU 50MM M14	4490,00
C4837	DIJ.KRUNA ZA BRUSILICU 55MM M14	5104,00
C4840	DIJ.KRUNA ZA BRUSILICU 68MM M14	6212,00
C4844	DIJ.KRUNA ZA BRUSILICU 82MM M14	7396,00

Otwornica diamentowa / Vacuum brazed drill / Сверло алмазное



Symbol	Ø	M14	l	Ø
C4816	6	M14	1	42
C4817	8	M14	1	42
C4818	10	M14	1	42
C4819	12	M14	1	42
C4822	16	M14	1	20
C4824	20	M14	1	20
C4826	25	M14	1	20
C4829	30	M14	1	20
C4831	35	M14	1	20
C4834	45	M14	1	10
C4835	50	M14	1	10
C4837	55	M14	1	10
C4840	68	M14	1	3
C4844	82	M14	1	3



Szczotka do szlifarki stożkowa  
Round brush

R6-200mm

Szczotka do szlifarki stożkowa  
Cone-shaped cup brush

R6-200mm

Szczotka do szlifarki stożkowa  
Cone-shaped cup brush

R6-200mm



C4303	ČELIČNA ČETKA ZA BRUSILICU 100MM x M14	320,00
C4304	ČELIČNA ČETKA ZA BRUSILICU 75MM X M14	235,00
C4305	ČELIČNA ČETKA ZA BRUSILICU 100MM x M14	417,00
C4307	ČELIČNA ČETKA ZA BRUSILICU-PLETENICA 80MM K22005	367,00



C4325	ČELIČNA ČETKA ZA BUŠILICU 25MM	117,00
C4319	ČELIČNA ČETKA ZA BUŠILICU 75MM K22031	195,00
C4307	ČELIČNA ČETKA ZA BUŠILICU-PLETENICA 80MM K22024	367,00
C4354	ČELIČNA ČETKA RUČNA 270MM	116,00

Nitownica / Hand riveter / Заклепочник

C0704 24/32/40/48 6 24

Nitownica PROFÍ / Hand riveter Professional / Заклепочник PROFÍ

C0705 24/32/40/48 6 24

Nitownica nożycowa z zasobnikiem / Hand nut riveter Professional / Заклепочник доручний

C0670 32/40/48/56/64/72/80 4 10

Olejarka / Oiler / Масленка

C0617 250 10 120

C0704	KLJEŠTA ZA POP NITNE	628,00
C0705	KLJEŠTA ZA POP NITNE PROFÍ	968,00
C0740	DVORUCNA KLJEŠTA ZA POP NITNE PROFESSIONAL 450 MM	1928,00
C0697	KATICA ZA ULJE METALNA 250 ML	290,00

Końcówka do smarownicy / Jaw clamp / Наконечник

M10x1

Wężyc giętki do smarownicy wzmocniony PROFÍ / Flexible hose reinforced Professional / Гибкий шланг с усиленным аппаратом усиленным

M10x1 10000 PSI

Wężyc metalowy do smarownicy / Metal hose / Металлический шланг для смазочных шприцов

M10x1

C0722	DEKALAMIT MAZALICA 500ML PROFESSIONAL + 2 HOSES	2050,00	
C0780	DIZNA ZA DEKALAMIT MAZALICU M10x1	145,00	
C0765	FLEXIBLE CREVO ZA MAZALICU 10.000 PSI, 30 CM THREAD M10x1	168,00	
C0766	FLEXIBLE CREVO ZA MAZALICU 10.000 PSI, 50 CM THREAD M10x1	210,00	
C0770	METALNA CEV ZA MAZALICU 1,2MMx24CM THREADT M10x1	85,00	
C0805	STAPLE GUN 4-14MM - HEFTALICA	Zszywacz tapicerski 4-14mm / Staple gun 4-14mm Zszywki tapicerskie typ 53 / Staples type 53	1308,00
C0806	MUNICIJA ZA HEFT. 6MM TYPE 53	128,00	
C0808	MUNICIJA ZA HEFT. 8MM TYPE 53	128,00	
C0810	MUNICIJA ZA HEFT. 10MM TYPE 53	141,00	
C0812	MUNICIJA ZA HEFT. 12MM TYPE 53	158,00	
C0814	MUNICIJA ZA HEFT. 14MM TYPE 53	163,00	

		
--	--	--

C1920	PCV IZOLIR TRAKA 10Mx19MM COLOUR	65,00
C1920C	PCV IZOLIR TRAKA 10Mx19MM BLACK	65,00
C1924	TRAKA ZA PAKOVANJE BRAON 48MMx35M	95,00
C1926	TRAKA ZA PAKOVANJE PROVIDNA 48MMx35M	95,00
C1947	UNIVERSAL TRAKA 48MMx 23M ENHANCED	212,00

		
---	--	--

C2541	ČEKIĆ TESARSKI FIBERGLASS 600G	1075,00
C2604	ČEKIĆ GUMENI 90 BLACK-WHITE WOODEN HANDLE	740,00

		
--	--	--

		
--	--	--

C2542	ČEKIĆ ZIDARSKI FIBERGLASS 600G	885,00
C2224	ČEKIĆ TESARSKI METALNI	1196,00
C2228	ČEKIĆ TESARSKI METALNI PROFESSIONAL	1870,00

		
--	--	--



C8004	PIŠTOLJ ZA SILIKON 240MM		730,00
C8007	PIŠTOLJ ZA SILIKON 240MM EXCLUSIVE		1425,00
C3620	KANAP ZA OBELEZAVANJE I PRASAK 115G		675,00

C4912	CARGO TRAKA 2M, 1T,		347,00
C4914	CARGO TRAKA 4M, 1T,		392,00
C4916	CARGO TRAKA 6M, 1T,		433,00
C4918	CARGO TRAKA 8M, 1T,		480,00
C4902	CARGO TRAKA 2M, 2T		668,00
C4904	CARGO TRAKA 4M, 2T		767,00
C4906	CARGO TRAKA 6M, 2T		885,00
C4908	CARGO TRAKA 8M, 2T		933,00

C5004	CARGO TRAKA 4M 5T		1420,00
C5006	CARGO TRAKA 6M 5T		1620,00
C5008	CARGO TRAKA 8M 5T		1793,00
C5010	CARGO TRAKA 10M 5T		1962,00
C5012	CARGO TRAKA 12M 5T		2229,00
C5014	CARGO TRAKA 14M 5T		2354,00
C5016	CARGO TRAKA 16M 5T		2481,00

C0450	MAGNETNA DRZAC TRAKA 50 CM		792,00
C0452	MAGNETNA TACNA 15 CM		495,00
C0453	MAGNETNA TACNA 15x35 CM		1287,00
C0457	TELESKOPSKI MAGNET - LIFT CAPACITY 4 KG		306,00

C0463	FLEKSIBILNI TELESKOPSKI MAGNET SA LED SVETLOM - LIFT CAPACITY 2 KG		594,00
C0460	INSPEKCIJSKO OGLEDALO		315,00
C0462	TELESKOPSKI SET		1290,00
C0485	FLEKSIBILNA MEHANICKA HVATALJKA		300,00

C0840	LEPAK ZA PISTOLJ TRANSPARENT 11 MM (BOX 1 KG)				1336,00
C0002	ZASTITNE NAOČARE YSA1				140,00
C0012	KOFIL MASKA, CLASS FFP1				77,00
C3395	GARNITURA ZUMBI 2-20MM				789,00

C0418	SET TERMOSKUPLJAJUCIH ABAZURA 128 PCS					588,00
-------	---------------------------------------	---	---	--	---	--------

C0400	SET GUMICA MALI 225 PCS.	520,00
C0411	SET GUMICA VELIKI 419 PCS.	1313,00
C0412	SET GUMICA ZA KLIMA SISTEME 270 PCS	636,00

B1043	METAR 3Mx16MM		142,00
B1044	METAR 5Mx19MM		200,00
B1045	METAR 7,5Mx25MM		359,00
B1046	METAR 10Mx25MM		430,00

C1033	METAR PROFESIONAL ERGONOMIC 3 M/16 MM NYLON	317,00
C1036	METAR PROFESIONAL EGONOMIC MAGNETIC 5 M/25MM NYLON	597,00

C1343	METAR DRVENI 1M		280,00
C1344	METAR DRVENI 2M		443,00
C1355	MERNA TRAKA FIBERGLASS PROFESSIONAL 20 M		986,00
C1357	MERNA TRAKA FIBERGLASS PROFESSIONAL 50 M		1699,00



C3426	POMICNO MERILO 150mm auto-lock	1878,00	
C3427	POMICNO MERILO 200mm	2187,00	
C3429	POMICNO MERILO 300mm	3231,00	
C0125	OLOVKA ZA OBELEZAVANJE-STOLARSKA 25 CM 55 PCS/BOX	1=42.00	2310,00
C0225	OLOVKA ZA OBELEZAVANJE-KAMENOREZACKE 25 CM 55 PCS/BOX	1=42.00	2310,00
C9260	STEPENASTA BURGIJA METAL 4-12 MM		475,00
C9261	STEPENASTA BURGIJA METAL 4-20 MM		735,00
C9262	STEPENASTA BURGIJA METAL 4-32 MM		1550,00
C9263	STEPENASTA BURGIJA METAL 4-39 MM		1980,00
C9264	<b>STEPENASTA BURGIJA METAL 4-52 MM</b>		2250,00

C8205	MASINA ZA KERAMIKU 1000MM		9990,00
C8223	NOZ ZA MASINU ZA KERAMIKU TITANIJUMSKI		325,00

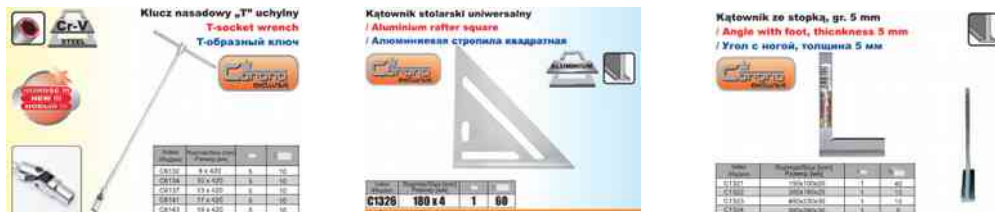

C6134	T-KLJUC ZGLOBNI 10x450MM	760,00
C6137	T-KLJUC ZGLOBNI 13x450MM	760,00
C6141	T-KLJUC ZGLOBNI 17x450MM	790,00
C6143	T-KLJUC ZGLOBNI 19x450MM	790,00

C1326	ALUMINIJUMSKI MERNI TROUGAO 180x4 MM	885,00
-------	--------------------------------------	--------



C1327	ALUMINIJSKI MERNI TROUGAO 300x4,4 MM	1997,00
C1321	UGAONIK 150x100x20 MM DEBLJINA 5 MM	798,00
C1322	UGAONIK 300x180x25 MM DEBLJINA 5 MM	1297,00
C1324	UGAONIK 500x280x30 MM DEBLJINA 5 MM	1957,00

Katkovnik nastavny  
Bevel protractor



Model	Ukupna dužina	Ukupna visina
C1324	300	1/2
C1322	300	1/2
C1321	150	1/2

Richmann

Katkovnik  
Protractor



Model	Ukupna dužina	Ukupna visina
C1324	300	1/2
C1322	300	1/2
C1321	150	1/2

C1374	RICHMANN UGAONIK FLEKSIBILNI 350MM	1.650,00
C1375	RICHMANN UGAONIK FLEKSIBILNI 500MM	1.750,00
C1376	RICHMANN UGAONIK FLEKSIBILNI 750MM	1.950,00

C1371	RICHMANN UGAONIK 500MM	1.285,00
C1372	RICHMANN UGAONIK 750MM	1.479,00
C1373	RICHMANN UGAONIK 1000MM	1.952,00

C9600	SDS + BURGIJA ZA BETON 5x110MM	107,00
C9601	SDS + BURGIJA ZA BETON 5x160MM	131,00
C9604	SDS + BURGIJA ZA BETON 6x110MM	115,00
C9605	SDS + BURGIJA ZA BETON 6x160MM	129,00
C9606	SDS + BURGIJA ZA BETON 6x210MM	156,00
C9607	SDS + BURGIJA ZA BETON 6x260MM	174,00
C9608	SDS + BURGIJA ZA BETON 6,5x160 MM	133,00
C9609	SDS + BURGIJA ZA BETON 6,5x210 MM	175,00
C9610	SDS + BURGIJA ZA BETON 6,5x260 MM	183,00
XT70716	SDS + BURGIJA ZA BETON 6,5x160MM-PROFI	222,00
XT70721	SDS + BURGIJA ZA BETON 6,5x210MM-PROFI	275,00
C9746	SDS + BURGIJA ZA BETON 6,5x260MM-PROFI	337,00
C9612	SDS + BURGIJA ZA BETON 8x110MM	135,00
C9613	SDS + BURGIJA ZA BETON 8x160MM	153,00
C9614	SDS + BURGIJA ZA BETON 8x210MM	194,00
C9615	SDS + BURGIJA ZA BETON 8x260MM	202,00
C9616	SDS + BURGIJA ZA BETON 8x350MM	254,00
C9617	SDS + BURGIJA ZA BETON + DRILL 8x450MM	298,00
C9618	SDS + BURGIJA ZA BETON 8x600MM	495,00
C9628	SDS + BURGIJA ZA BETON 10x1000MM	955,00
C9619	SDS + BURGIJA ZA BETON 10x110MM	159,00
C9620	SDS + BURGIJA ZA BETON 10x160MM	185,00
C9621	SDS + BURGIJA ZA BETON 10x210MM	205,00
C9622	SDS + BURGIJA ZA BETON 10x260MM	235,00
C9623	SDS + BURGIJA ZA BETON 10x310MM	272,00
C9626	SDS + BURGIJA ZA BETON 10x450MM	342,00
C9627	SDS + BURGIJA ZA BETON 10x600MM	515,00
C9638	SDS + BURGIJA ZA BETON 12x1000 MM	869,00
C9630	SDS + BURGIJA ZA BETON 12x160MM	218,00
C9631	SDS + BURGIJA ZA BETON 12x210MM	249,00
C9632	SDS + BURGIJA ZA BETON 12x260MM	269,00
C9633	SDS + BURGIJA ZA BETON 12x310MM	298,00
C9636	SDS + BURGIJA ZA BETON 12x450MM	451,00
C9637	SDS + BURGIJA ZA BETON 12x600MM	526,00
C9646	SDS + BURGIJA ZA BETON 14x1000MM	930,00
C9639	SDS + BURGIJA ZA BETON 14x210MM	327,00
C9640	SDS + BURGIJA ZA BETON 14x260MM	350,00
C9641	SDS + BURGIJA ZA BETON 14x310MM	384,00



C9644	SDS + BURGIJA ZA BETON 14x450MM	585,00
C9645	SDS + BURGIJA ZA BETON 14x600MM	716,00
C9654	SDS + BURGIJA ZA BETON 16x1000MM	1160,00
P81616	SDS + BURGIJA ZA BETON 16x160MM	345,00
C9647	SDS + BURGIJA ZA BETON 16x210MM	472,00
C9648	SDS + BURGIJA ZA BETON 16x260MM	511,00
C9649	SDS + BURGIJA ZA BETON 16x310MM	545,00
C9652	SDS + BURGIJA ZA BETON 16x450MM	592,00
C9653	SDS + BURGIJA ZA BETON 16x600MM	793,00
C9662	SDS + BURGIJA ZA BETON 18x1000MM	1388,00
C9655	SDS + BURGIJA ZA BETON 18x210MM	539,00
C9657	SDS + BURGIJA ZA BETON 18x310MM	630,00
C9659	SDS + BURGIJA ZA BETON 18x450MM	765,00
C9660	SDS + BURGIJA ZA BETON 18x600MM	963,00
C9666	SDS + BURGIJA ZA BETON 20x1000MM	1590,00
C9663	SDS + BURGIJA ZA BETON 20x400MM	973,00
C9664	SDS + BURGIJA ZA BETON 20x600MM	1215,00
C9670	SDS + BURGIJA ZA BETON 22x1000MM	2036,00
C9667	SDS + BURGIJA ZA BETON 22x400MM	1130,00
C9668	SDS + BURGIJA ZA BETON 22x600MM	1475,00
C9674	SDS + BURGIJA ZA BETON 24x1000MM	2705,00
C9671	SDS + BURGIJA ZA BETON 24x400MM	1420,00
C9672	SDS + BURGIJA ZA BETON 24x600MM	1850,00
C9678	SDS + BURGIJA ZA BETON 26x1000MM	3420,00
C9676	SDS + BURGIJA ZA BETON 26x600MM	2346,00
C9679	SDS + BURGIJA ZA BETON 28x600MM	3361,00
C9681	SDS + BURGIJA ZA BETON 30x600MM	4665,00

P91610	SDS MAX BURGIJA ZA BETON 16x1000MM	2265,00
P91640	SDS MAX BURGIJA ZA BETON 16x400MM	950,00
P91660	SDS MAX BURGIJA ZA BETON 16x600MM	1250,00
P91810	SDS MAX BURGIJA ZA BETON 18x1000MM	2416,00
P91840	SDS MAX BURGIJA ZA BETON 18x400MM	1250,00
P91860	SDS MAX BURGIJA ZA BETON 18x600MM	1495,00
P92010	SDS MAX BURGIJA ZA BETON 20x1000MM	2450,00
P92040	SDS MAX BURGIJA ZA BETON 20x400MM	1280,00
P92060	SDS MAX BURGIJA ZA BETON 20x600MM	1950,00
P92210	SDS MAX BURGIJA ZA BETON 22x1000MM	2890,00
P92240	SDS MAX BURGIJA ZA BETON 22x400MM	1610,00
P92260	SDS MAX BURGIJA ZA BETON 22x600MM	1950,00
P92410	SDS MAX BURGIJA ZA BETON 24x1000MM	3300,00
P92440	SDS MAX BURGIJA ZA BETON 24x400MM	1637,00
P92460	SDS MAX BURGIJA ZA BETON 24x600MM	2350,00
P92610	SDS MAX BURGIJA ZA BETON 26x1000MM	3820,00
P92640	SDS MAX BURGIJA ZA BETON 26x400MM	1900,00
P92660	SDS MAX BURGIJA ZA BETON 26x600MM	2360,00
P92810	SDS MAX BURGIJA ZA BETON 28x1000MM	4758,00
P92840	SDS MAX BURGIJA ZA BETON 28x400MM	2430,00
P92860	SDS MAX BURGIJA ZA BETON 28x600MM	3250,00
P93010	SDS MAX BURGIJA ZA BETON 30x1000MM	5250,00
P93060	SDS MAX BURGIJA ZA BETON 30x600MM	4250,00
P93210	SDS MAX BURGIJA ZA BETON 32x1000MM	5780,00
P93260	SDS MAX BURGIJA ZA BETON 32x600MM	4650,00
P93610	SDS MAX BURGIJA ZA BETON 36x1000MM	7680,00
P93660	SDS MAX BURGIJA ZA BETON 36x600MM	6100,00





P93810	SDS MAX BURGIJA ZA BETON 38x1000MM	8650,00
P93860	SDS MAX BURGIJA ZA BETON 38x600MM	6150,00
P94010	SDS MAX BURGIJA ZA BETON 40x1000MM	9350,00
P94060	SDS MAX BURGIJA ZA BETON 40x600MM	6750,00



C5840	ŠPIC SDS+ 14x250 MM	225,00
C5841	DLETO SDS+ 14x250x20 MM	225,00
C5842	DLETO DUGAČKO 40MM SDS+ 14x250	285,00



C8905	ROTACIONO GLODALO GRUBO ZYA 8x20 A0820	850,00
C8906	ROTACIONO GLODALO GRUBO ZYA 10x20MM A1020	1150,00
C8907	ROTACIONO GLODALO GRUBO ZYA 12x25MM A1225	1750,00
C8908	ROTACIONO GLODALO FINO ZYA/ST 8x20MM B0820	885,00
C8909	ROTACIONO GLODALO FINO ZYA/ST 10x20MM B1020	1190,00
C8910	ROTACIONO GLODALO FINO ZYA/ST 12x25MM B1225	1780,00



C8911	ROTACIONO GLODALO ZAoblJENO WRC 8x20MM C0820	850,00
C8912	ROTACIONO GLODALO ZAoblJENO WRC 10x20MM C1020	1085,00
C8913	ROTACIONO GLODALO ZAoblJENO WRC 12x25MM C1225	1650,00
C8914	ROTACIONO GLODALO OKRUGLO KUD 8x7MM D0807	450,00
C8915	ROTACIONO GLODALO OKRUGLO KUD 10x9MM D1009	590,00
C8916	ROTACIONO GLODALO OKRUGLO KUD 12x11MM D1211	760,00



C8920	ROTACIONO GLODALO KONUSNO KEL 8x22MM L0822	750,00
C8921	ROTACIONO GLODALO KONUSNO KEL 10x25MM L1025	952,00
C8922	ROTACIONO GLODALO KONUSNO KEL 12x28MM L1228	1360,00
C8923	ROTACIONO GLODALO ŠPIC SKM 8x18MM M0818	665,00
C8924	ROTACIONO GLODALO ŠPIC SKM 10x20MM M1020	785,00
C8925	ROTACIONO GLODALO ŠPIC SKM 12x25MM M1225	1135,00

C8936	3-FLUTE UPUŠTAČ 6,3x45x5 MM	330,00
C8937	3-FLUTE UPUŠTAČ 8,3x50x6 MM	440,00
C8938	3-FLUTE UPUŠTAČ 10,4x50x6 MM	506,00
C8939	3-FLUTE UPUŠTAČ 12,4x56x8 MM	869,00
C8940	3-FLUTE UPUŠTAČ 16,5x60x8 MM	1045,00
C8941	3-FLUTE UPUŠTAČ 20,5x63x10 MM	1639,00

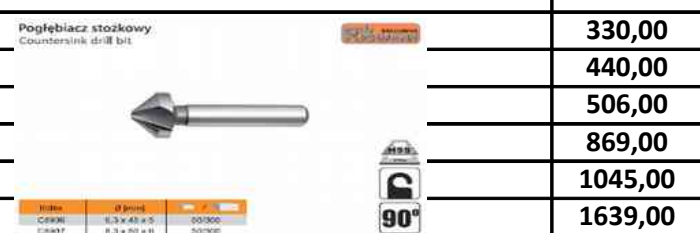









		C2917	150	50/200	125 mm	
C4671	125 MM PLASTIČAN DRŽAČ BRUSNOG PAPIRA M14+DODATAK ZA BUŠILICU					211,00
C2912	FLAP DISC 125MM/ 40					20,00
C2913	FLAP DISC 125MM/ 60					20,00
C2914	FLAP DISC 125MM/ 80					20,00
C2915	FLAP DISC 125MM/ 100					20,00
C2916	FLAP DISC 125MM/ 120					20,00
C2917	FLAP DISC 125MM/ 150					20,00
C2918	FLAP DISC 125MM/ 180					20,00

C4790	BLOK ZA BRUŠENJE 100x70x25MM GR 36	Klocek szlifierski 100x70x25mm Sanding block 100x70x25mm		72,00
C4792	BLOK ZA BRUŠENJE 100x70x25MM GR 60			72,00
C4793	BLOK ZA BRUŠENJE 100x70x25MM GR 80			72,00
C4794	BLOK ZA BRUŠENJE 100x70x25MM GR 100			72,00
C4795	BLOK ZA BRUŠENJE 100x70x25MM GR 120			72,00
C4796	BLOK ZA BRUŠENJE 100x70x25MM GR 150			72,00
C4797	BLOK ZA BRUŠENJE 100x70x25MM GR 180			72,00
C4798	BLOK ZA BRUŠENJE 100x70x25MM GR 220			72,00

10504314N	IRWIN MAKAZE ZA LIM-UNIVERZALNE		1390,00
	 		

153673	RAIDER BURGIJA SDS PLUS QUADRO Ø14x160 MM	180,00
	KLJUČE Ø1,6 mm 200g	284,00
	OSTATA KLJEŠTA	172,00

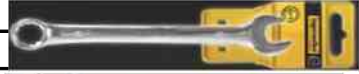
	NASADNI KLJUČ 1/2 11MM		69,00
	NASADNI KLJUČ 1/2 12MM		69,00
	NASADNI KLJUČ 1/2 14MM		69,00
	NASADNI KLJUČ 1/2 15MM		69,00
	NASADNI KLJUČ 1/2 16MM		69,00
	NASADNI KLJUČ 1/2 18MM		91,00
	NASADNI KLJUČ 1/2 22MM		105,00
	NASADNI KLJUČ 1/2 27MM		180,00
	NASADNI KLJUČ 1/2 32MM		226,00

221533	ODVIJAČ-KRATKI- RAVNI 6*38	98,00	
230101	VILJUŠKASTI KLJUČ 6*7		57,00
230102	VILJUŠKASTI KLJUČ 8*9		60,00
230109	VILJUŠKASTI KLJUČ 21*23	244,00	
230504	OKASTO VILJUŠKASTI KLJUČ 9		61,00
230507	OKASTO VILJUŠKASTI KLJUČ 12		75,00
230515	OKASTO VILJUŠKASTI KLJUČ 20	175,00	
230915	OKASTI KLJUČ 21*23		300,00
230917	OKASTI KLJUČ 25*28		411,00
231903	OKASTO-VILJ KLJUČ SA KRCKALICOM 10		396,00

			
C2301	LIBELA RICHMANN 40 CM MADE BY KAPRO	939,00	
C2302	LIBELA RICHMANN 60 CM MADE BY KAPRO	1310,00	

C2303	LIBELA RICHMANN 80 CM MADE BY KAPRO	1531,00
C2304	LIBELA RICHMANN 100 CM MADE BY KAPRO	1690,00
C2305	LIBELA RICHMANN 120 CM MADE BY KAPRO	1990,00
C2306	LIBELA RICHMANN 150 CM MADE BY KAPRO	2470,00
C2307	LIBELA RICHMANN 180 CM MADE BY KAPRO	2990,00
C2308	LIBELA RICHMANN 200 CM MADE BY KAPRO	3290,00

C2001	FUTROLA ZA LIBELU 40 CM	 <p>Pokrowiec do poziomicy RICHMANN Cover for the RICHMANN levels</p> <table border="1"> <thead> <tr> <th>Model</th> <th>Długość</th> <th>Waga</th> <th>Wymiary</th> </tr> </thead> <tbody> <tr> <td>COMPACT</td> <td>40</td> <td>0,08</td> <td>1,1/10</td> </tr> <tr> <td>COMPACT</td> <td>50</td> <td>0,09</td> <td>1,1/10</td> </tr> <tr> <td>COMPACT</td> <td>60</td> <td>0,10</td> <td>1,1/10</td> </tr> <tr> <td>COMPACT</td> <td>75</td> <td>0,12</td> <td>1,1/10</td> </tr> <tr> <td>COMPACT</td> <td>100</td> <td>0,15</td> <td>1,1/10</td> </tr> <tr> <td>COMPACT</td> <td>120</td> <td>0,18</td> <td>1,1/10</td> </tr> <tr> <td>COMPACT</td> <td>150</td> <td>0,22</td> <td>1,1/10</td> </tr> <tr> <td>COMPACT</td> <td>180</td> <td>0,27</td> <td>1,1/10</td> </tr> <tr> <td>COMPACT</td> <td>200</td> <td>0,30</td> <td>1,1/10</td> </tr> </tbody> </table>	Model	Długość	Waga	Wymiary	COMPACT	40	0,08	1,1/10	COMPACT	50	0,09	1,1/10	COMPACT	60	0,10	1,1/10	COMPACT	75	0,12	1,1/10	COMPACT	100	0,15	1,1/10	COMPACT	120	0,18	1,1/10	COMPACT	150	0,22	1,1/10	COMPACT	180	0,27	1,1/10	COMPACT	200	0,30	1,1/10	145,00
Model	Długość		Waga	Wymiary																																							
COMPACT	40		0,08	1,1/10																																							
COMPACT	50		0,09	1,1/10																																							
COMPACT	60		0,10	1,1/10																																							
COMPACT	75		0,12	1,1/10																																							
COMPACT	100		0,15	1,1/10																																							
COMPACT	120		0,18	1,1/10																																							
COMPACT	150		0,22	1,1/10																																							
COMPACT	180	0,27	1,1/10																																								
COMPACT	200	0,30	1,1/10																																								
C2002	FUTROLA ZA LIBELU 60 CM	155,00																																									
C2003	FUTROLA ZA LIBELU 80 CM	185,00																																									
C2004	FUTROLA ZA LIBELU 100 CM	205,00																																									
C2005	FUTROLA ZA LIBELU 120 CM	225,00																																									
C2006	FUTROLA ZA LIBELU 150 CM	265,00																																									
C2007	FUTROLA ZA LIBELU 180 CM	305,00																																									
C2008	FUTROLA ZA LIBELU 200 CM	335,00																																									



KA779-40	KAPRO LIBELA SPIRIT MAGNETNA 40 CM	1.380,00
KA779-60	KAPRO LIBELA SPIRIT MAGNETNA 60 CM	1.380,00
KA779-80	KAPRO LIBELA SPIRIT MAGNETNA 80 CM	1.611,00
KA779-100	KAPRO LIBELA SPIRIT MAGNETNA 100 CM	1.879,00
KA779-120	KAPRO LIBELA SPIRIT MAGNETNA 120 CM	2.537,00
KA779-150	KAPRO LIBELA SPIRIT MAGNETNA 150 CM	2.992,00
KA779-200	KAPRO LIBELA SPIRIT MAGNETNA 200 CM	3.390,00



KA770-100	KAPRO LIBELA SA METROM 100 CM EXODUS	2.680,00
-----------	--------------------------------------	----------



KA783-47	KAPRO LIBELA ZA ELEKTRICARE 47 CM	1.850,00
----------	-----------------------------------	----------

Poziomica COMPACT, aluminiowa  
Aluminium level COMPACT

Poziomica COMPACT, plastikowa  
Plastic level COMPACT

Poziomica HANDY 10 cm  
Level HANDY 10 cm

KAPRO



Model	L [cm]	Waga
KA923	25	10/20



Model	L [cm]	Waga
KA929	25	10/20

Model	L [cm]	Waga
KA246	10	10/100



KA923	KAPRO MAGNETNA LIBELA "COMPACT" 25 CM ALUMINIUM	1.995,00
KA929	KAPRO MAGNETNA LIBELA "COMPACT" 25 CM PLASTICNA	925,00
KA246	KAPRO MALA LIBELA 10 CM	515,00

Poziomica do słupów  
Folding post level

KAPRO











Poziomica do rur, 5 elementów  
Level pipe, 5 pcs

KAPRO



Model	Waga	Wymiary
10"	1,0 kg	1,0 m
12"	1,2 kg	1,2 m
14"	1,4 kg	1,4 m
16"	1,6 kg	1,6 m
18"	1,8 kg	1,8 m

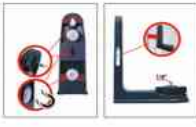

				
<b>KA340</b>	<b>KAPRO LIBELA ZA PROFILE</b>			<b>950,00</b>
<b>KA350</b>	<b>KAPRO LIBELA ZA CEVI 5 PCS</b>			<b>1.880,00</b>
				
<b>KA301</b>	<b>KAPRO UGAONIK MERNI FLEKSIBILNI T-BEVEL</b>			<b>565,00</b>
<b>KA317</b>	<b>KAPRO FLEKSIBILNI UGAONIK ZA GIPS CARTON BOARD</b>			<b>3.680,00</b>
				
<b>KA841</b>	<b>KAPRO ADAPTER ZA STALAK 5/8' x 1/4'</b>			<b>780,00</b>
<b>KA886-58</b>	<b>TELESKOPSKI STALAK ZA LASER 1/4', MAX 3,2M</b>			<b>6.990,00</b>
<b>KA886-23</b>	<b>KAPRO UNIVERZALNI MAGNETNO ZIDNI DRZAC LASERA</b>			<b>3.350,00</b>
<b>KA894-04</b>	<b>KAPRO CRVENI LASER DETEKTOR</b>			<b>7.371,00</b>
	<b>DETEKTOR METALA, STRUJNIH VODOVA, PLASTIKE I DRVETA</b>			
		<b>AUTOMATSKO SKENIRANJE I ZVUCNO OBAVESTAVANJE</b>		
		<b>Maksimalna dubina skeniranja:</b>		
		- metal: 50mm		
		- strujne žice: 50mm		
		- bakarne cevi: 30mm		
		- metalne cevi: 38mm		
		- drvo: 18mm		
		<b>ISPORUKA BEZ BATERIJE OD 9V</b>		
<b>KA389</b>	<b>KAPRO MULTISKENER DETEKTOR</b>			<b>3.690,00</b>
	<b>KRSTASTI SAMONIVELISUCI LASER</b>			
	<b>DO 15 METARA MERENJA</b>			
	<b>TACNOST 0.4mm/METAR-2 LINIJE</b>			
	<b>ZASTITA OD VODE I PRASINE IP54</b>			
	<b>PRIHVAT ZA STATIV 1/4"</b>			
	<b>KA842-CRVENI LASER</b>			
<b>KA842</b>	<b>KAPRO LASER LEVEL BAMBINO</b>			<b>3.990,00</b>
	<b>KRSTASTI SAMONIVELISUCI LASER</b>			
	<b>priključak za postolje - tripod 1/4" navoj</b>			
	<b>gumirano kućište otporno na udarce</b>			
	<b>samonivelisanje: +- 5°-2 LINIJE</b>			
	<b>tačnost: 0.2 mm/m</b>			
	<b>opseg unutrašnji: 30m</b>			
	<b>opseg spoljašnji sa detektorom: 50m</b>			
	<b>KA872-CRVENI SA STALKOM</b>			
	<b>KA872G-ZELENI</b>			
<b>KA872G</b>	<b>KAPRO LASER LEVEL GREEN, RANGE 30 M</b>			<b>16.615,00</b>
	<b>SAMONIVELISUCI KRSTASTI LASER</b>			
	<b>priključak za postolje - tripod 1/4" 5/5" navoj</b>			
	<b>gumirano kućište otporno na udarce</b>			
	<b>tačnost: 0.2 mm/m</b>			

*opseg unutrašnji: 30m*  
*opseg spoljašnji sa detektorom: 50m*  
*vidno i čujno upozorenje "iznad nivoa"*

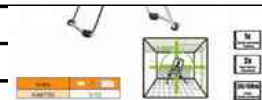

<b>KA873G</b>	<b>KAPRO SAMONIVELISUCI LASER ZELENI 3 LINIJE</b>	<b>18.900,00</b>
---------------	---	------------------

















































1000  
1000























